

ELECTRONIC-LTPS FAUCETS

116.807.AB.1

Electronic Sensor Faucets



Product Type

Deck Mounted Single Hole HyTronic Traditional Sink Faucet with Dual Beam Infrared Sensor - Patient Care Application

Features & Specifications

- Single Hole
- Traditional Electronic Integral Spout
- 2.2 GPM (8.3 L/min) Vandal Proof Aerator
- Dual Supply for Hot and Cold Water Service
- Powered from Long Term Power System (LTPS)- DC
- 3/8" O.D. Copper Supply Tubes
- Concealed Internal Temperature Control
- Multiple Field Adjustable Modes and Ranges
- Compatible with Chicago Faucets Commander™ Handheld Programming Unit
- External Thermostatic Mixing Valve Included
- 1/2" NPT Inlet x 3/8" O.D. Female Compression Outlet Angle Stop Included
- 376-CXSTJKABNF Slow compression cartridge, integral check, for high temperatures
- Includes slip wall flange and 2-1/4" tee handle
- Designed Specifically for Patient Care Applications
- ECAST® design provides durable construction with total lead content equal to or less than 0.25% by weighted average

Performance Specification

- Rated Operating Pressure: 20-125 PSI
- Rated Operating Temperature: 40-160°F
- *Note: 180°F max. during temporary high-temperature system flush

Warranty

- Lifetime Limited Faucet Warranty
- 1-Year Limited Finish Warranty
- 5-Year Limited Mechanical Warranty
- 3-Year Limited Electronics and Solenoid Warranty

Codes & Standards

- Certified to NSF/ANSI 61, Section 9 by CSA
- ASSE 1070/ASME A112.1070/CSA B125.70
- ADA ANSI/ICC A117.1

Job Name _____

Item Number _____

Section/Tag _____

Model Specified _____

Architect _____

Engineer _____

Contractor _____

Submitted as Shown Submitted with Variations

Date _____



ECAST

ECAST products are intended for installation where state laws and local codes mandate lead content levels or in any location where lead content is a concern.



2100 South Clearwater Drive
Des Plaines, IL
P: 847/803-5000
F: 847/803-5454
Technical: 800/TEC-TRUE
www.chicagofaucets.com

Architect/Engineer Specification

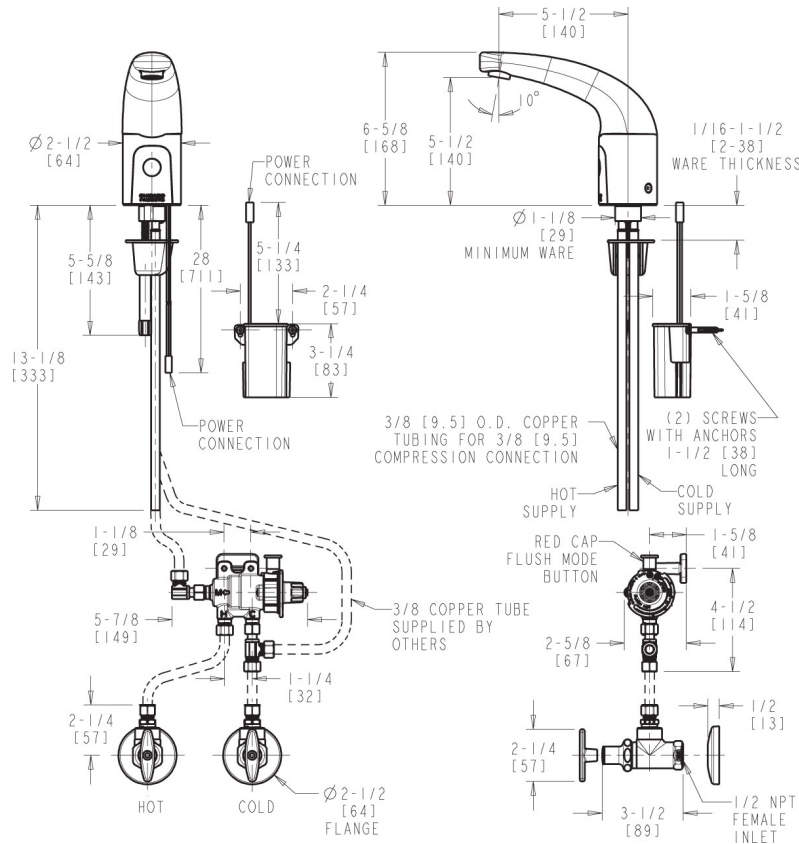

Operation and Maintenance

Installation should be in accordance with local plumbing codes. Flush all pipes thoroughly before installation. After installation, remove spout outlet or flow control and flush faucet thoroughly to clear any debris. Care should be taken when cleaning the product. Do not use abrasive cleaners, chemicals or solvents as they can result in surface damage. Use mild soap and warm water for cleaning and protecting the life of Chicago Faucet products. For specific operation and maintenance refer to the installation instructions and repair parts documents that are located at www.chicagofaucets.com.

Chicago Faucets, member of the Geberit Group, is the leading brand of commercial faucets and fittings in the United States, offering a complete range of products for schools, laboratories, hospitals, office buildings, food service, airports and sport facilities. Call 1.800.TECTRUE or 1.847.803.5000 Option 1 for installation or other technical assistance.

