

Model# 80047-UA3

Two Handle Wallmount Kitchen Faucet

FEATURES & SPECIFICATIONS

- Canopy Handles
- 12" Tube Swivel Spout
- 1/2-14 NPS Female Thread
- Ceramic Disc Cartridges
- 2-Hole 7-7/8" to 8-1/8" Installation
- 1.5 GPM Flow Rate
- 1.5 GPM Flow Rate

FINISHES

- PC Polished Chrome

STANDARDS

- ASME A112.18.1
- ANSI / NSF 61, SECTION 9
- CUPC / IAPMO LISTED
- ANSI A117.1 / ADA COMPLIANT



FLOW

- 1.5 GPM Flow Rate

WARRANTY

- Lifetime Limited Warranty
- Lifetime Residential Warranty
- 5 Year Commercial Warranty

80047-UA3/REV. 11 2016

Product Specifications subject to change without notice

Job Name _____ Date _____
Model Specified _____ QTY _____
Customer/Wholesaler _____
Contractor _____
Architect/Engineer _____
Submitted as Shown _____
Submitted w/ Variations _____

Model# 80047-UA3

Two Handle Wallmount Kitchen Faucet

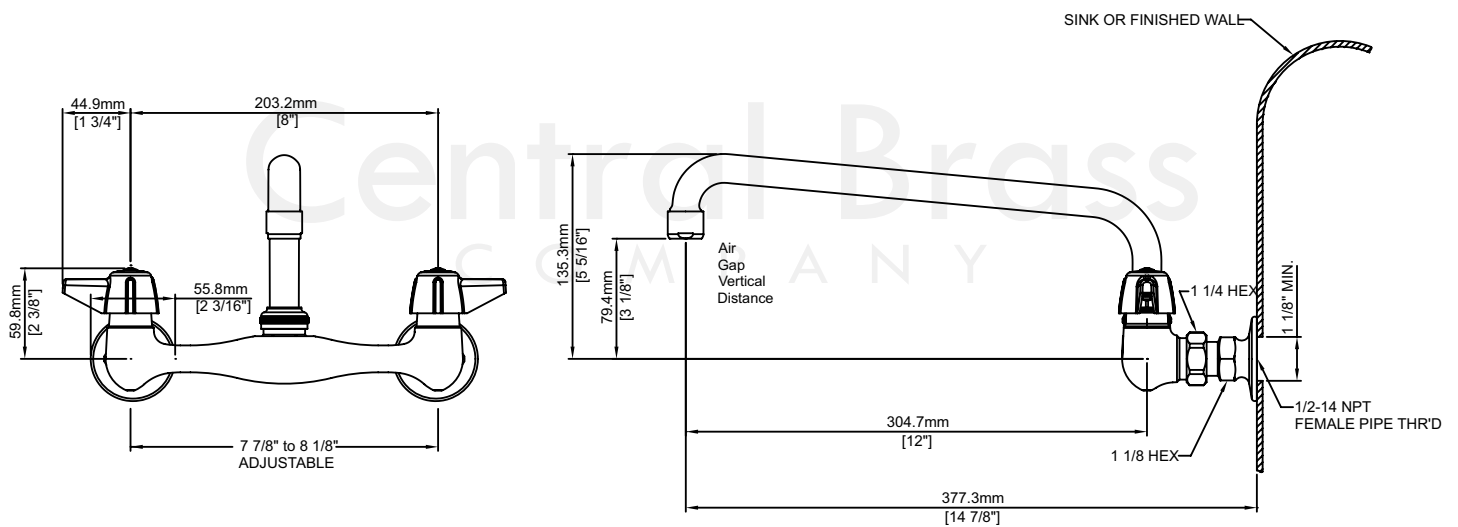

80047-UA3/REV. 11 2016

Product Specifications subject to change without notice