

Model# 0122-LE1

Two Handle Cast Brass Kitchen Faucet

FEATURES & SPECIFICATIONS

- 2-3/8" Lever Handle
- 8" Tube Swivel Spout
- Replaceable Seats
- 3-Hole 8" Installation
- 1.5 GPM Flow Rate
- 1.5 GPM Flow Rate

FINISHES

- PC Polished Chrome

STANDARDS

- ASME A112.18.1
- ANSI A117.1 / ADA COMPLIANT



FLOW

- 1.5 GPM Flow Rate

WARRANTY

- Lifetime Limited Warranty
- Lifetime Residential Warranty
- 5 Year Commercial Warranty

0122-LE1/REV. 11 2016

Product Specifications subject to change without notice

Job Name _____ Date _____
Model Specified _____ QTY _____
Customer/Wholesaler _____
Contractor _____
Architect/Engineer _____
Submitted as Shown _____
Submitted w/ Variations _____

Model# 0122-LE1

Two Handle Cast Brass Kitchen Faucet

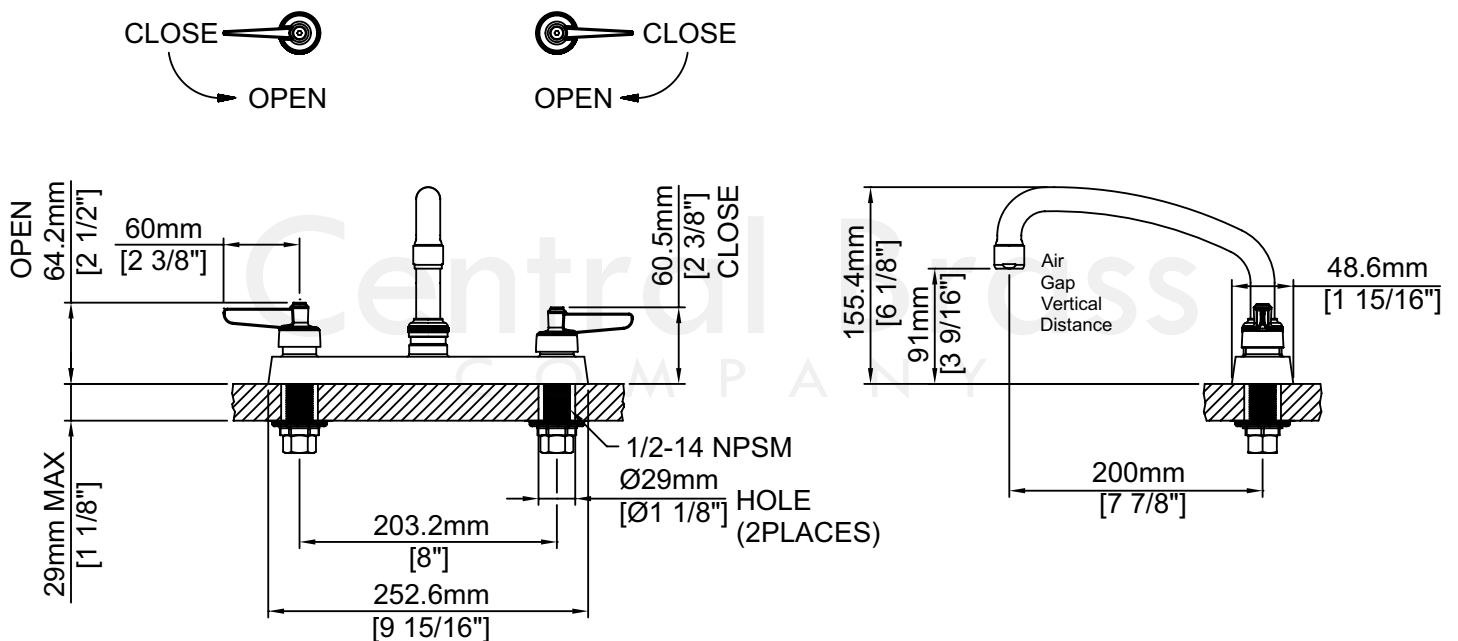

0122-LE1/REV. 11 2016

Product Specifications subject to change without notice