



**9205-64**

**Features**

- Available in over 30 finishes including 11 PVD finishes
- All brass construction
- 6" spout reach
- 1/2" NPT inlet

**Codes/Standards Applicable**

Specified model meets or exceeds the following:

- ASME A112.18.1/CSA B125.1

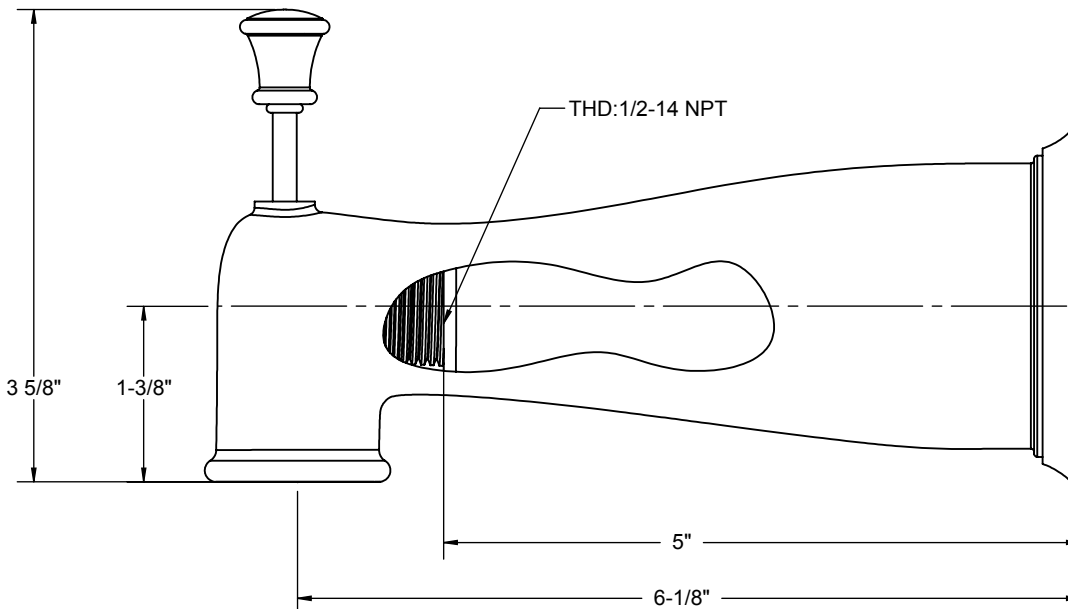
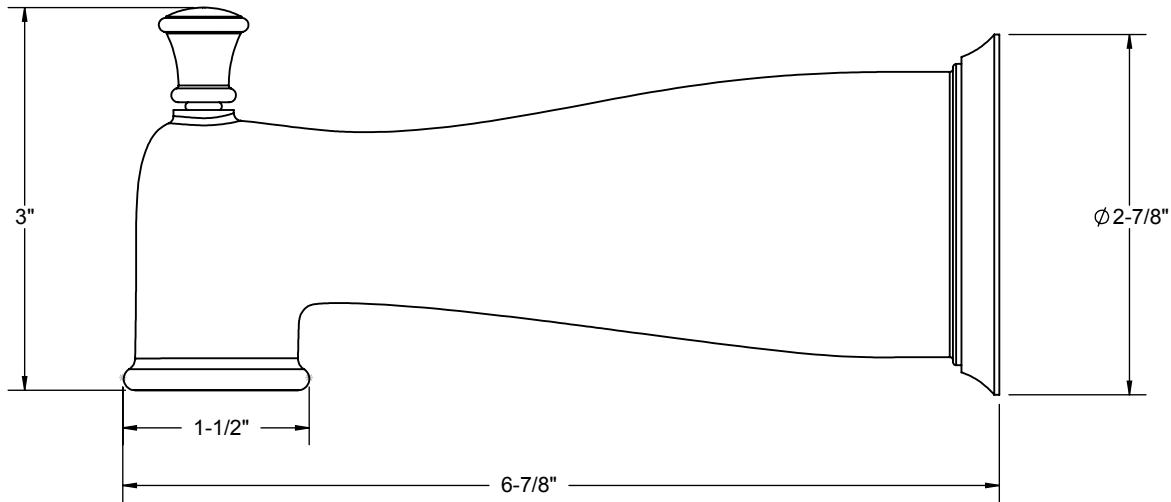
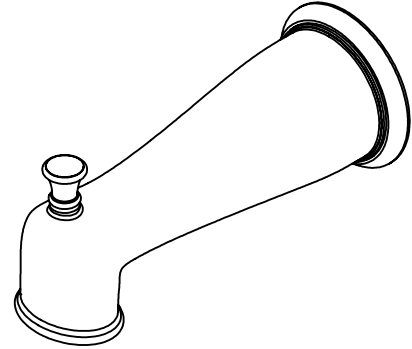

DIMENSIONS SHOWN TO NEAREST 1/16"