

### Dual Post Items

(For dimensions on center see Fig. 9)

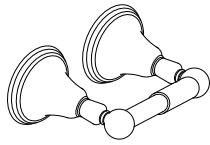

Fig. 1

#### Toilet Paper Holder

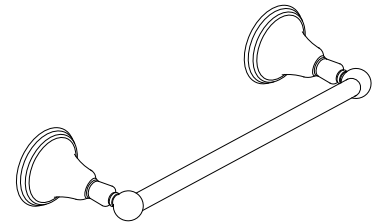
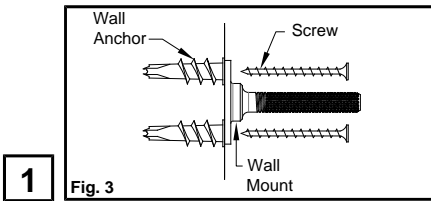

Fig. 2

#### Towel Bar



**1** Fig. 3

Install wall mount to wall with screws and anchors. Check with level. See Fig. 9 for proper centering.

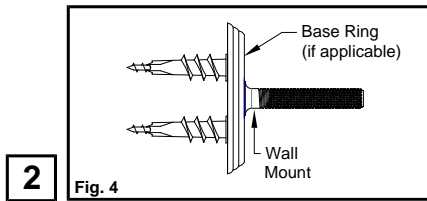

**2** Fig. 4

If supplied, place base rings against wall over the wall mounts.

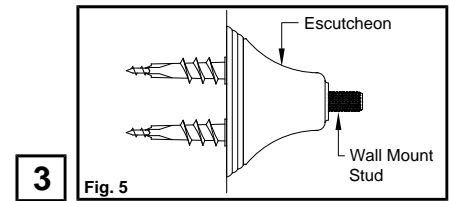

**3** Fig. 5

Thread escutcheons onto wall mount stud and against wall.

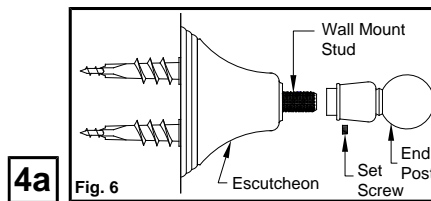

**4a** Fig. 6

Slide end posts onto wall mount studs & up against escutcheons.

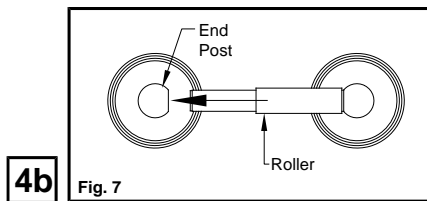

**4b** Fig. 7

For toilet paper holder, Align end post holes toward each other & tighten set screws. Compress roller & insert roller into end post holes.

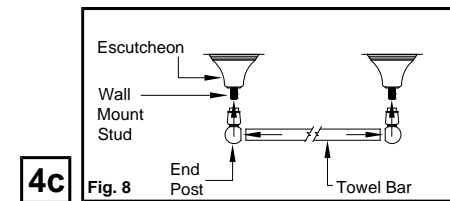

**4c** Fig. 8

For towel bar, insert towel bar into both end post holes & tighten both set screws.

#### Dimensions On Center

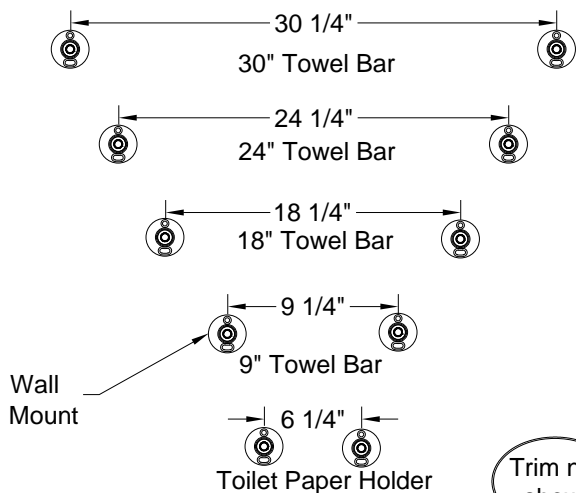

Fig. 9

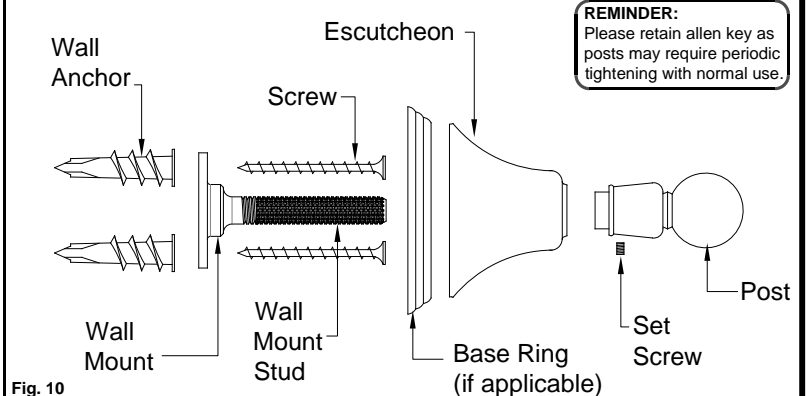

Fig. 10

**REMINDER:** Please retain allen key as posts may require periodic tightening with normal use.

#### IMPORTANT CLEANING NOTICE

Please refer to *Finish Care Instructions* for complete cleaning information. Wipe frequently with a soft, damp cloth. Never use acids, harsh abrasives or detergents.

### Single Post Items

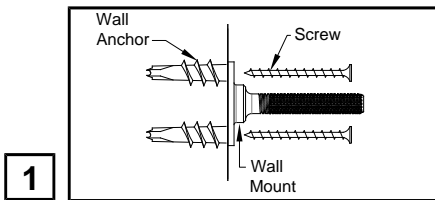
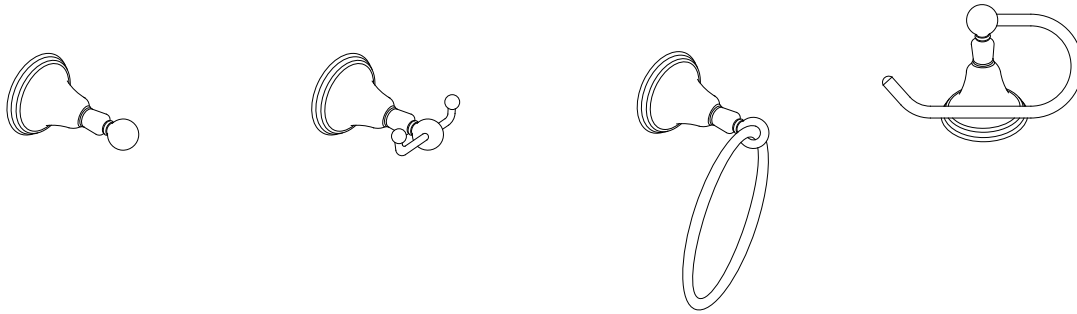

**1** Install wall mount to wall with screws & anchors

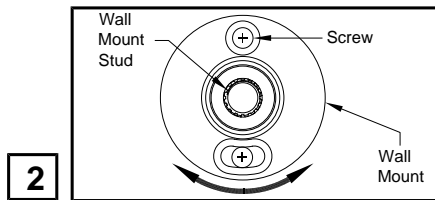

**2** Install 1 screw at top of mount, place end post onto wall mount stud & rotate bracket for proper alignment; Tighten lower screw.

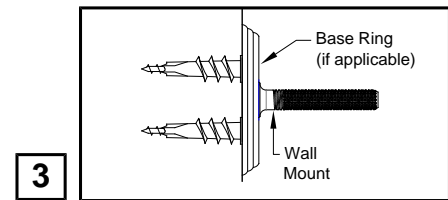

**3** If supplied, place base rings against wall over the wall mounts.

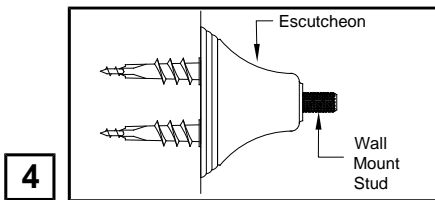

**4** Thread escutcheon onto wall mount stud and against wall.

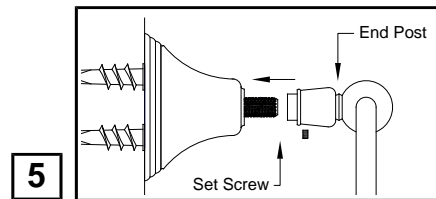

**5** Slide end post onto wall mount stud up against escutcheon & tighten setscrew

**REMINDER:**  
 Please retain allen key as posts may require periodic tightening with normal use.

