



Tisto Drain

9170-BFA, 9171-BFA, 9172-BFA, 9173-BFA, 9174-BFA,
9175-BFA, 9176-BFA, 9177-BFA, 9179-BFA, 9190-BFA,
9170-BFP, 9171-BFP, 9172-BFP, 9173-BFP, 9174-BFP,
9175-BFP, 9176-BFP, 9177-BFP, 9179-BFP, & 9190-BFP

Bonding Flange Drain Installation Instructions

CALIFORNIA FAUCETS RECOMMENDS THAT ALL PLUMBING PRODUCTS BE INSTALLED
BY A LICENSED PROFESSIONAL

NOTE: FOLLOW ALL STATE AND LOCAL PLUMBING CODES & REQUIREMENTS

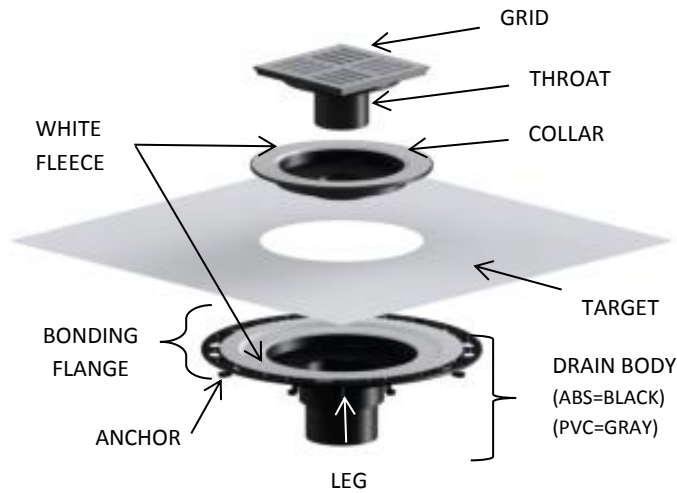

Installing Tisto Drain in Mortar Bed

Step 1

- Determine the layout of the shower area (Fig. A-1)
- Concrete or wood subfloor will need a 3-3/4" to 4-1/4" round through hole for the drain body
- Through Hole shall be centered above the P-Trap

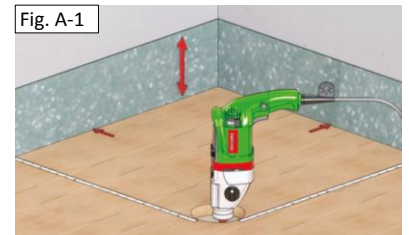

Step 1A (Wood Subfloors Only)

- Lay vapor barrier (not supplied) to wood subfloor of the shower area. Vapor Barrier is placed between wood subfloor & mortar bed which is applied at a later time
- Vapor Barrier prevents the wood subfloor from absorbing moisture

Step 2

- The minimum height is 1" and is determined by the one inch legs (Fig. A-2)
- Determine correct length of pipe extension needed to connect drain outlet to P-trap (Fig A-3)
- Remove the drain body and cut extension to measured length. The inside diameter of the drain body accepts ABS or PVC pipe 2" in diameter. The outside diameter of the drain accepts pipe 3" in diameter. If connecting to a 3" pipe, use a 3" coupling

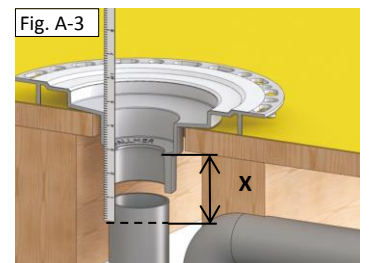
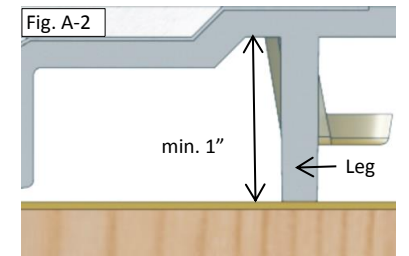

Step 3

- Connect extension pipe to drain by applying correct solvent cement to the drain outlet & the pipe. Follow instructions that come with the Solvent Cement
- Connect pipe to P-trap using solvent cement (Fig. A-4) Check to make sure drain is level (Fig. A-5) Allow the solvent cement to dry before performing a leak test on the drain connection in accordance with local building & plumbing codes (Fig. C-6)

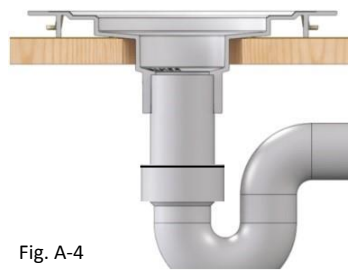

Fig. A-4

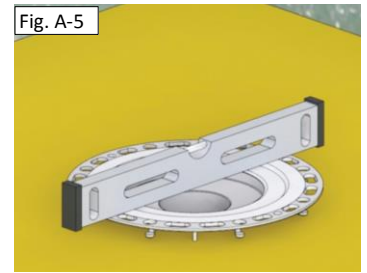

Fig. A-5

Step 4

- Pack sufficient mortar under the bonding flange to ensure the drain body is securely supported (Fig. A-6, A-7)
- Use a wetter mortar for packing under the flange to make it easier to fill gaps
- Clean excess mortar from the top of the bonding flange and wipe off any mortar that gets on the **fleece** (white material on flange)

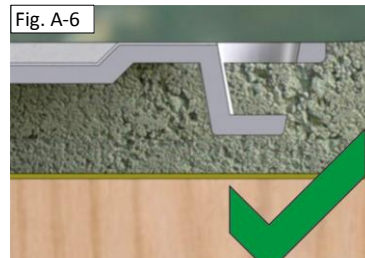

Fig. A-6



Fig. A-7

Creating a Slope Using a Mortar Bed

Step 5

- Fill the remainder of the shower base with mortar
- Float mortar bed down to drain flange at a 2% grade (1/4" per linear Ft. minimum) (Fig. A-8)
- The mortar bed should be level with the top edge of the drain body (A-9)



Fig. A-8

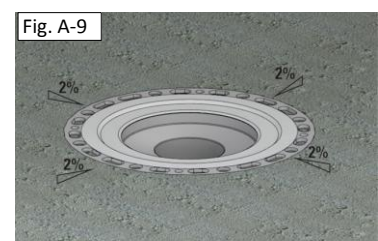

Fig. A-9

Note: Water Proofing can be either **Method A** or **Method B**

Installing Tisto Drain with Preformed Shower Tray

Note: Tisto Drain must seat properly into the molded contour of preformed tray to be used with preformed tray. (Fig. B-1) (Preformed tray not supplied.)

Step 1

- The concrete or wood subfloor will need a 3-3/4" to 4-1/4" round through hole for the drain body
- Drain hole in TRAY needs to be 6 1/2" in diameter, if necessary cut away material to increase diameter of hole (Fig B-2)
- Remove the ANCHORS & LEGS on the TISTO DRAIN with pliers (Fig. B-3)
- Check to see if drain fits into molded contour of tray

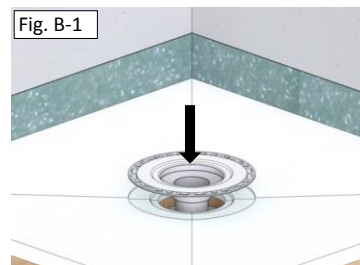

Fig. B-1

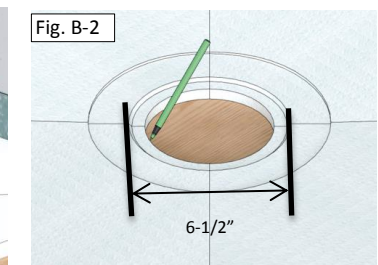

Fig. B-2

Step 2

- Apply Unmodified Thin-Set Mortar to the subfloor using a 1/4" x 3/8" square or U-notched trowel (Fig. B-4)
- Place the tray in position and make sure that tray gets solidly embed in the Unmodified Thin-Set Mortar (Fig. B-5)

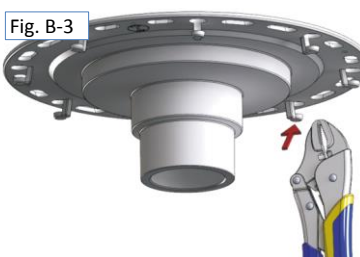

Fig. B-3

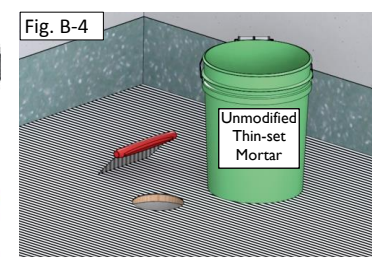

Fig. B-4

Step 3

- Dry fit to determine correct length of pipe extension needed to connect drain outlet to P-trap (Fig B-6)
- Remove the drain body and cut extension to measured length. The inside diameter of the drain body accepts ABS or PVC pipe 2" in diameter. The outside diameter of the drain accepts pipe 3" in diameter. If connecting to a 3" pipe, use a 3" coupling

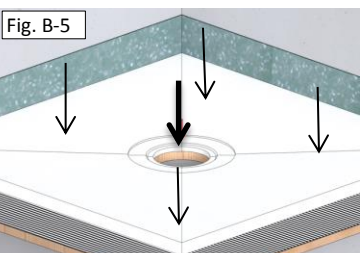

Fig. B-5

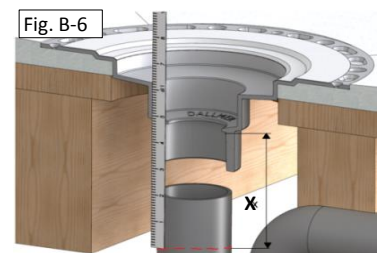
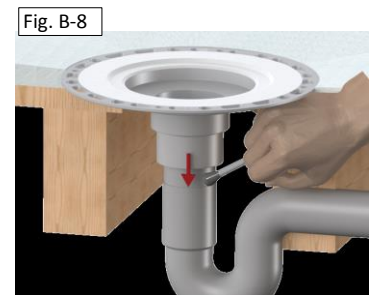
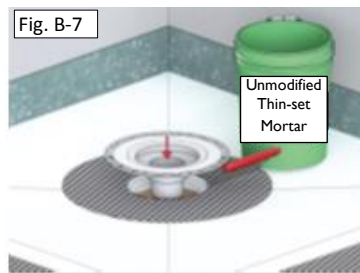

Fig. B-6

Step 4

- Fill the step in shower tray with Unmodified Thin-Set Mortar (Fig. B-7)
- Connect drain body & pipe extension using correct solvent cement (ABS or PVC)
- Apply solvent cement to P-trap & pipe extension (Fig. B-8)
- Push drain body with pipe extension into P-trap while pressing the drain firmly into the unmodified Thin-Set Mortar until it is fully supported



Note: Use Water Proofing Fabric Membrane, **Method B** with Preformed Shower Trays

Method A: Installing the Water Proofing Using a Liquid Applied Membrane (LAM)

Note: Allow mortar bed to dry according to the manufacturer's instructions before applying the water proofing. Make sure to follow manufacturer's instructions for Liquid Applied Membrane & have sufficient LAM for two coats.

Step 1

- Seal all corners with waterproof tape and/or preformed corners (Fig. C-1, C-2 & C-3)

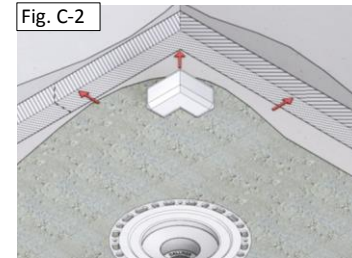
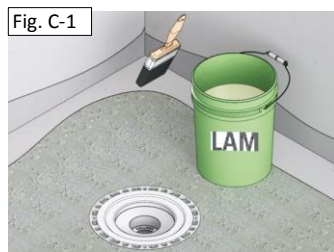

Step 2

- Apply the LAM onto the drain flange and the area surrounding the drain (C-4)
- The LAM should cover the entire flange except for the 1/2" step.
- Immediately lay the TARGET on the freshly coated drain & surrounding area making sure to line up the Target hole with drain body (Fig. C-4)
- Use a trowel to remove any air pockets from under the TARGET to ensure that the TARGET is embedded in the LAM
- Continue applying the first coat of LAM to the rest of the mortar bed.

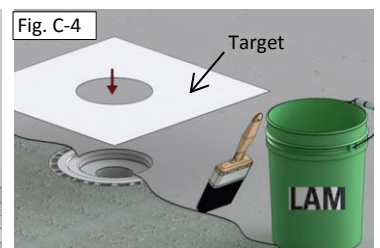
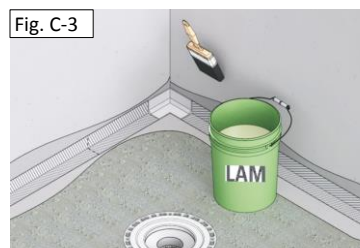

Note: Allow first coat of LAM to dry according to manufacturer's instructions. Apply second coat at right angle to first coat.

Step 3

- Apply the second coat of LAM to the entire shower area and over the TARGET (Fig. C-5)
- Allow water proofing to dry according to manufacturer's instructions.

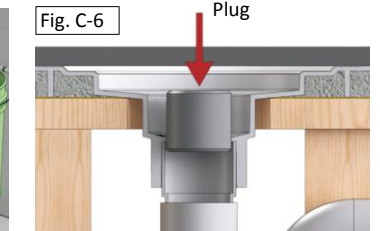

Note: Under some codes it may be necessary to plug the drain and perform a static flood test to the waterproofed pan. (Fig. C-6)

Method B: Installing the Water Proofing using a Fabric Membrane (Fabric membrane not supplied)

Step 1

- Measure & cut Fabric Membrane sufficient for the shower area
- Cut a 7 3/4" diameter hole in membrane where drain will be located (Fig. D-1)
- Fabric Membrane should cover entire mortar base & the top of the drain flange
- Put membrane aside for now

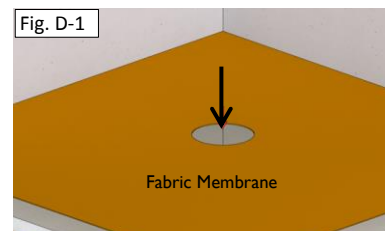

Step 2

- Using a 1/4" x 3/16" trowel, apply a layer of Unmodified Thin-Set Mortar to the shower base and to the upper level of the drain's bonding flange (Fig. D-2)
- Unmodified Thin-set Mortar is applied only to the outside 2" of the drain flange (Unmodified Thin-Set Mortar bonds membrane to the drain flange and mortar bed)

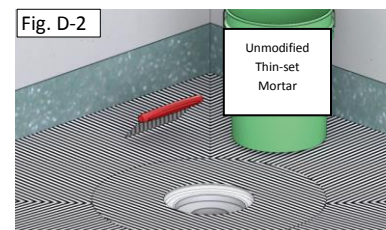

Step 3

- Unroll the membrane out over the surface of the Unmodified Thin-Set Mortar bed (Fig. D-3)
- Use trowel to embed the membrane into the Unmodified Thin-Set Mortar making sure to remove any air pockets
- Make sure that the connection between the fabric membrane & drain flange is secure

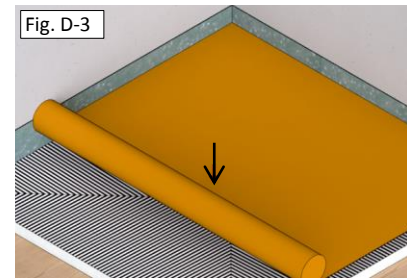

Step 4

- Follow installation instructions that come with fabric membrane to finish waterproofing the shower (Fig. D-4 & D-5)
- Allow water proofing to dry according to manufacturer's instructions
- Under some codes it may be necessary to plug the drain and perform a static flood test to waterproof pan (Fig. C-6)

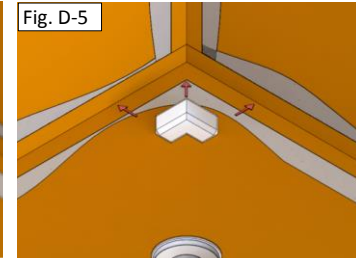
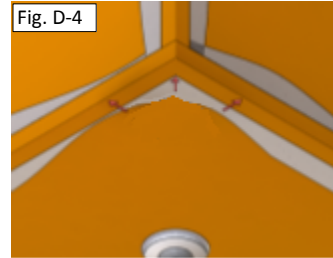

Installing StyleDrain® or Tile StyleDrain® Upgrade Kits

Preparing to Tile

Step 1

- The Collar sits inside the drain body (Fig. E-1) and is not fastened at this time
- Horizontal adjustments up to 3/16" can be made in tile pattern

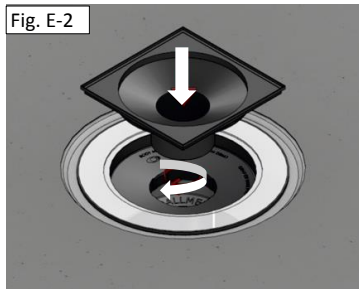
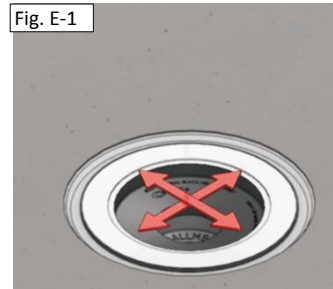

Step 2

- Thread the THROAT or TILE STYLEDRAIN OUTER FRAME onto the COLLAR (Fig. E-2) to determine the correct height needed for the tile. (Fig. E-3)
- Remember to take into account the thickness of the Thin-set and the tile when determining GRID or TILE COVER height
- Once the position of the COLLAR & THROAT are determined, place pea gravel over weep holes in COLLAR. (Fig. E-4)

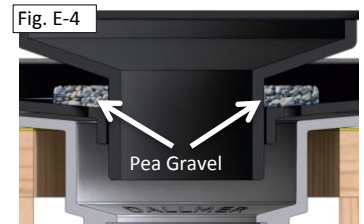
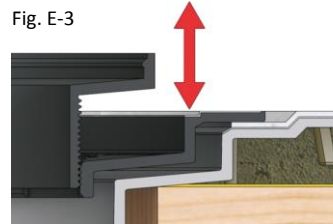

Step 3

- Pack the step in the COLLAR with Unmodified Thin-Set Mortar
- Thread THROAT down to the predetermined position forcing excess Thin-Set to squeeze out insuring that THROAT is fully supported (Fig. E-5)
- Start tiling following the instructions that came with Unmodified Thin-Set Mortar (Fig. E-6)
- COLLAR is locked in place by the Unmodified Thin-Set Mortar

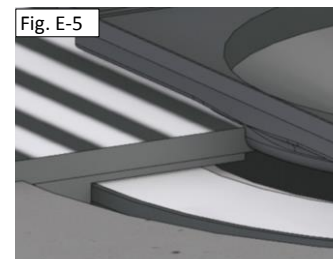

Installing StyleDrain® Grid into Throat

Step 4A

- Remove plastic cover in THROAT by drilling a hole in the center of plastic mudguard and pulling out
- Place DECORATIVE GRID onto the drain THROAT
- Find location of the Setscrews in GRID and tighten all screws securely with supplied Allen Key. (Fig. E-7)

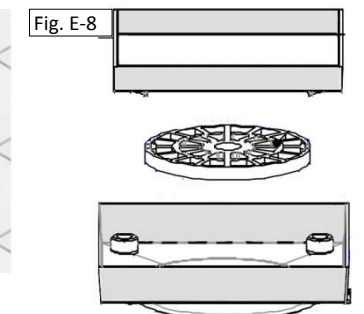

Installing Tile StyleDrain® Inner Frame

Step 4B (Fig. E-8)

- Place appropriate amount of THINSET into the INNER FRAME to achieve proper height level of COVER TILE to surrounding tiles
- Place STRAINER into THROAT
- Place INNER FRAME with COVER TILE into Outer Frame