

BRIZO®

KITCHEN FAUCETS

- Kintsu® Collection
- Single Handle Deck Mount

FEATURES:

- DIAMOND Seal® Technology
- MagneDock® Magnetic Docking
- Touch-Clean® Sprayhead
- Lumicoat® Finishes easily wipe clean without cleaners and chemicals on the products most commonly touched areas

STANDARD SPECIFICATIONS:

- Max flow rate 1.8 gpm @ 60 psi, 6.8 L/min @ 414 kPa
- One hole mount
- Spout rotates 360°
- Diamond coated ceramic cartridge
- Quick connect hoses
- Two-function wand: Aerated stream or spray
- Dual integral check valves in sprayer
- Handles sold separately. See handle options below

WARRANTY

- Parts and Finish – Lifetime limited warranty; or for commercial purchasers, 10 years for multi-family residential (apartments and condominiums) and 5 years for all other commercial uses, in each case from the date the product is received by the original purchaser or their authorized representative (installation contractor, etc.).
- Please go to www.brizo.com for the complete details of our limited warranty

COMPLIES WITH:

- ASME A112.18.1 / CSA B125.1
- NSF/ANSI/CAN 61 & 372
- ICC/ANSI A117.1 - Valve control only

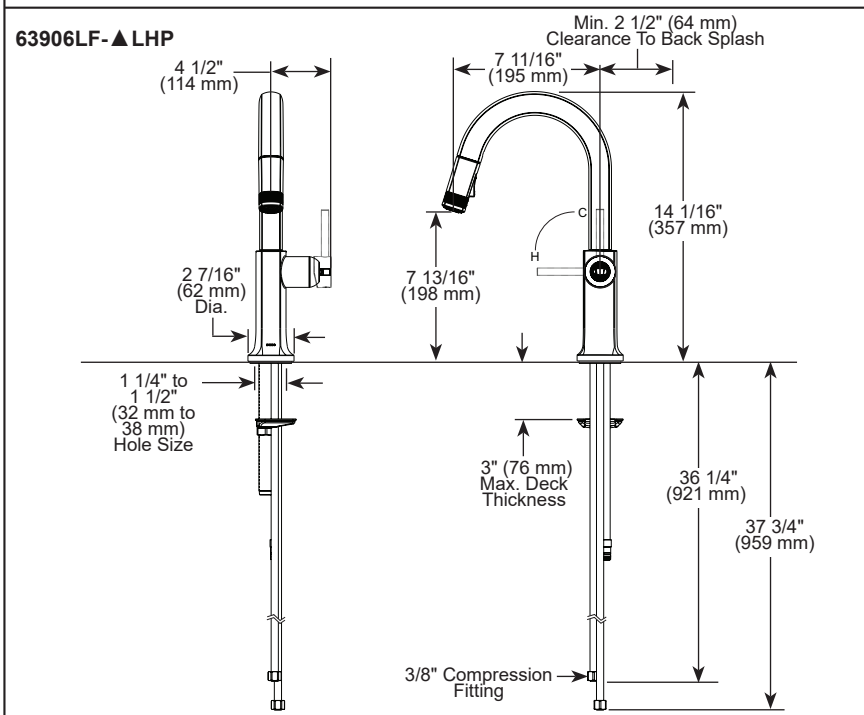
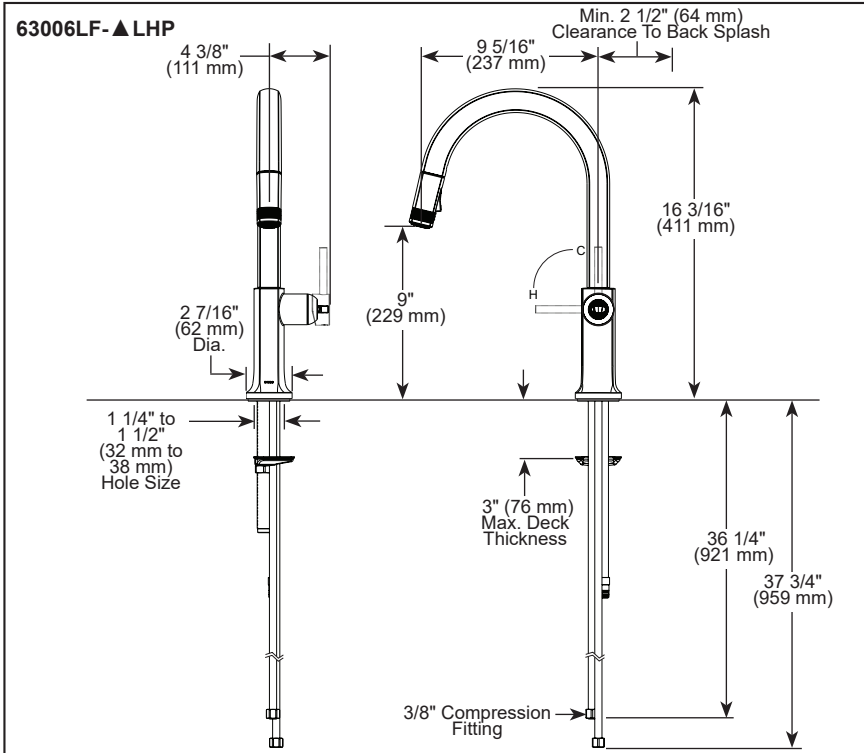

▲ Designate proper finish suffix

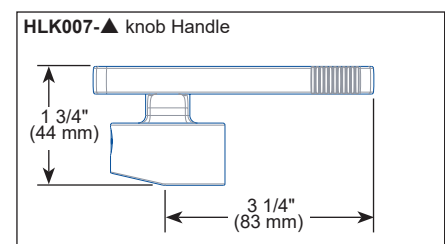
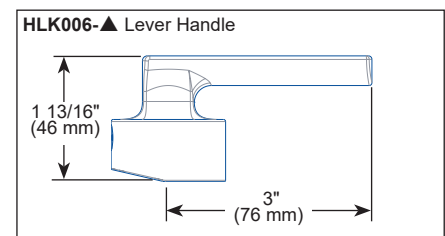

Brizo Kitchen & Bath Company reserves the right (1) to make changes in specifications and materials, and (2) to change or discontinue models, both without notice or obligation. Dimensions are for reference only. See current full-line price book or www.brizo.com for finish options and product availability.

BSP-K-63006LF-LHP Rev. C

Brizo Kitchen & Bath Company

55 E. 111th Street, Carmel, IN 46280
350 South Edgeware Road, St. Thomas, ON N5P 4L1
© 2026 Brizo Kitchen & Bath Company