

FXV1-1800 + FV1D-1800 SPECIFICATIONS

45° FENIX collection

FULL series 1800 wall-mount vanity

FEATURES:

- Wall-mount double vanity with two deep drawers, two slim drawer inserts + integrated basins
- Integrated infinity-style basin with central drain concealed by a sloped cover, without overflow
- Top + lower angles feature a unique 45 degree join
- Drawer organization included: 2 storage compartments, 4 cosmetic holders + 2 storage bins
- Slim inner drawer designed for plumbing clearance
- Recessed integral finger pull channel with Hettich soft-close system
- One continuous bracket along the backside for ease of installation: allows for easy retrofitting/hitting studs (Refer to the Installation Guide)
- Wall-mount design opens space & facilitates easy cleaning
- Italian-crafted for superior quality



SPECIFICATIONS:

Dimensions: (WHD) 71" x 19" x 20¼"
(1800mm x 480mm x 515mm)*

Shipping Dimensions (WHD) 75¼" x 23¼" x 24¼"
(1910mm x 590mm x 615mm)

Warranty: Five Year Limited Warranty (Residential)
One Year Warranty (Commercial)

ACCESSORIES (SOLD SEPARATELY):

- Recommend Geberit siphon traps: 151.116.11.1, 151.117.11.1 or 151.118.11.1

COLORS/FINISHES:

A VANITY FRAME

FENIX NTM™

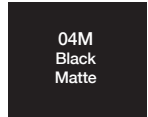

04M
Black
Matte

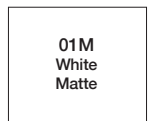

01M
White
Matte

B DRAWER FRONT

FENIX NTM™



04M
Black
Matte



01M
White
Matte

WOOD



02
Natural
Oak



03
Vintage
Oak



04
Distressed
Oak

LACQUER

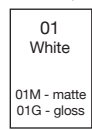

01
White

01M - matte
01G - gloss



04
Black

04M - matte
04G - gloss



62
Efeso

62M - matte
62G - gloss

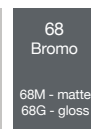

68
Bromo

68M - matte
68G - gloss

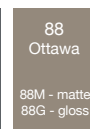

88
Ottawa

88M - matte
88G - gloss



90
Londra

90M - matte
90G - gloss

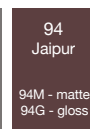

94
Jaipur

94M - matte
94G - gloss

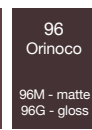

96
Orinoco

96M - matte
96G - gloss

Note: Wood is a natural product, therefore any variations in color, vein or finish on wood is considered part of the wood's value and craftsmanship.

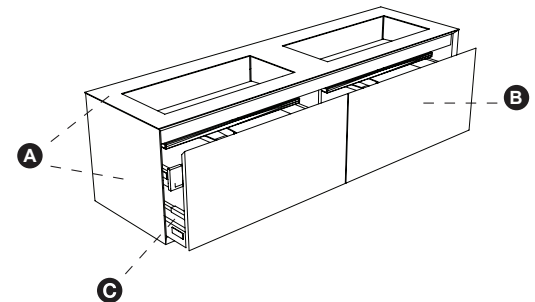

A FENIX NTM®

- B An innovative Nanotech material: a smart surface, extremely matte, fingerprint proof, soft to the touch but resistant to rubbing, abrasions, impacts, and thermally self-heals micro-scratches.

B Wood - Natural Oak

Constructed of real massif wood + wood veneer finish

Wood -Vintage Oak

Wood veneer on a multi layer birch wood panel

Wood - Distressed Oak/Everest

Solid wood three layer oak

Lacquer

Engineered wood (MDF) panel IDROCARB

C Solid rust free powder coating metal drawer with side glass

Hettich soft closing system

Drawer organization included



*Approximate measurements for comparison only.

Note: These dimensions and specifications are subject to change without notice.

FXV1-1800 + FV1D-1800 SPECIFICATIONS

45° FENIX collection

FULL series 1800 wall-mount vanity

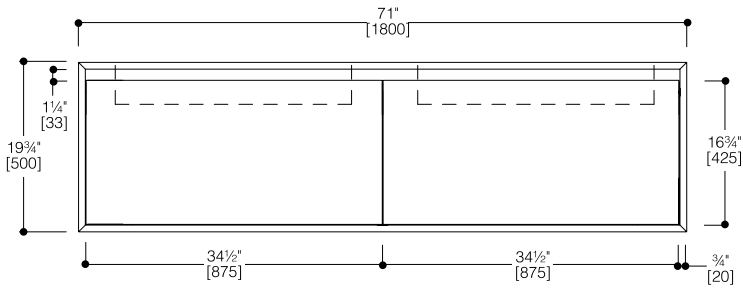

FRONT VIEW

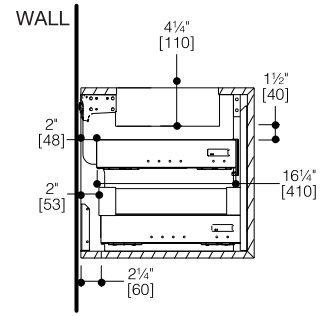

SIDE VIEW

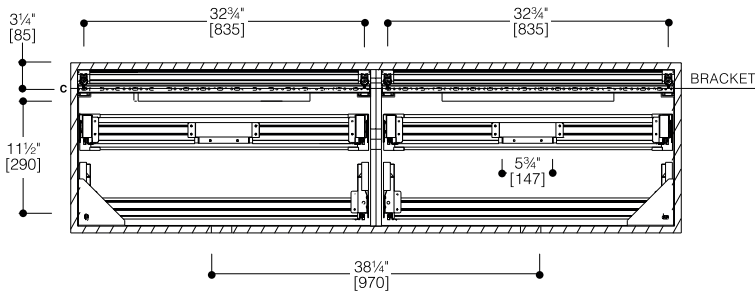

WALL DRILLING SCHEME FOR VANITY

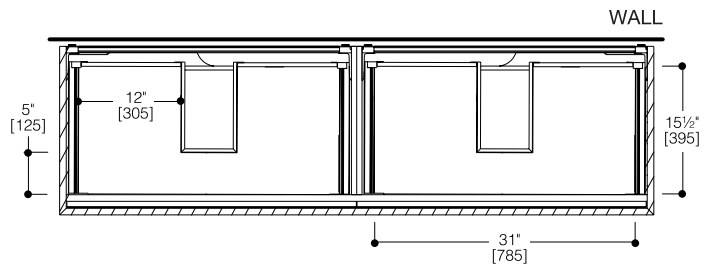

TOP DRAWER VIEW

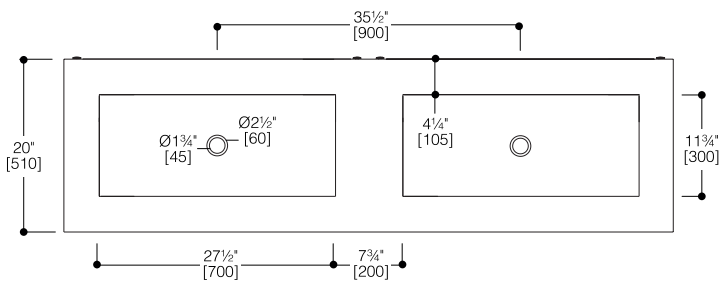

VANITY TOP VIEW

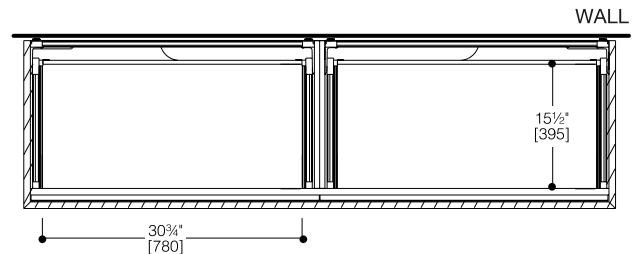

BOTTOM DRAWER VIEW

INSTALLATION NOTES:

Install this product according to the installation guide. Our products must be installed by professionals only and according to our installation guide as well as federal, provincial / state and local building codes and regulations.