

blu·stone™ countertop basins

Installation Guide

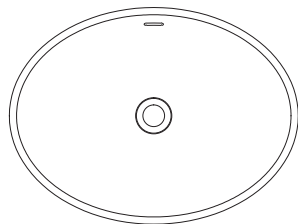

SA0102.01

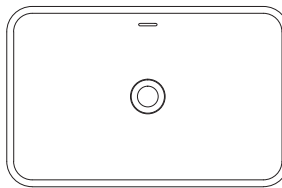

SA0204.01

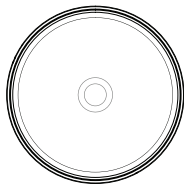

SA0107N37

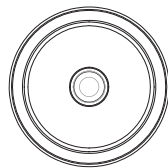

SA0107N38

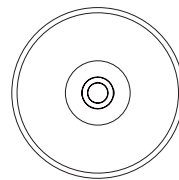

SA0210

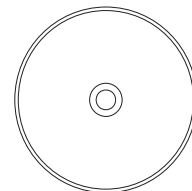

SA0211

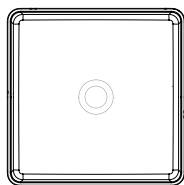

SA0209N37

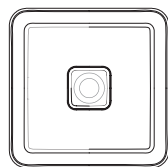

SA0209N38

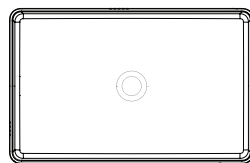

SA0305N37

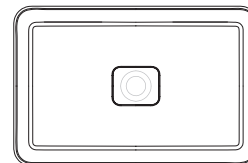

SA0305N38

Attention — Before Installation

If you are installing this product in a new construction or remodel, please make sure you are following all local plumbing and building codes. Carefully unpack and examine your new fixture for damage. To help insure that the installation process will proceed smoothly and correctly, please read these instructions carefully before you begin.

Installation Requirements

Please read the instructions carefully so as to avoid any damage to the fixture.

1. To ensure this product is installed properly, you must read and follow these guidelines.
2. The owner/user of the product must keep this information for future reference.
3. Consult local building codes to make sure the installation complies with standards.
4. Remove the unit from its packaging. Before disposing of it, inspect the unit to make sure its in good shape. Should inspection reveal any damage or defect in the finish, contact your distributor. The warranty does not cover damages or defects in the finish once it has been installed. Blu Bathworks' responsibility for shipping damages ceases upon delivery of the product in good order to the carrier. All complaints regarding damage due to transport must be made directly to the carrier.
5. Place the unit in the bathroom before you start working. Conserve all nuts and bolts.
6. To protect the unit during installation, we recommend that you lay a piece of cardboard on the bottom.
7. If the unit is covered with polyethylene protective film, do not remove until installation is complete to grant maximum protection. However, remove film where any two surfaces will be in permanent contact.
8. Verify that all dimensions on the plan are the same as the ones of the unit.

Installation Notes

Important! Install this product according to the installation guide. Product does have an overflow. Spout must provide a minimum of 5" reach for adequate clearance into basin. Our products must be installed by certified professionals only and according to our installation guide as well as federal, provincial / state and local building codes and regulations.

Technical Support Assistance

If further assistance is required, please contact:

Product Support at 1.866.907.0122 (09:00 – 17:00hrs PST) or email technical@blubathworks.com

North America

Blu Bathworks Inc.

188 Smithe Street, Vancouver, BC, Canada, V6B 6A9

T +1.604.299.0122 F +1.604.299.0125

Please refer to blubathworks.com for warranty, terms & conditions under warranty & procedure for warranty service.

Installation for Countertop Basins

NOTE: There is no template supplied with these basins

PREPARATION

1. Use the basin as a template.
2. Position the basin in the correct desired location and using a non-permanent marker draw an outline of the basin and drain hole.
3. Note: Allow adequate clearance between the backsplash and the lavatory. If the basin is being combined with either a deck mounted or wall faucet, mark the desired faucet location, making sure the chosen faucet has adequate clearance and reach.

INSTALLATION

4. Cut or drill out the drain opening on the counter top using the appropriate drill by following the drain opening cut line as illustrated.

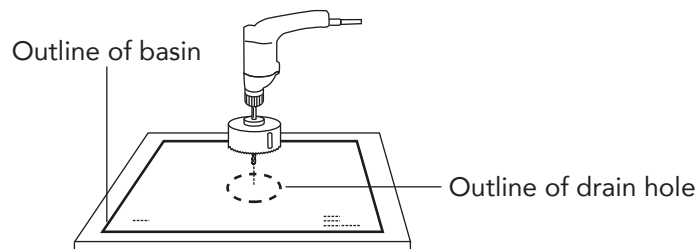

5. Temporarily set the lavatory on the counter top to check for fit.
6. Install the faucet and drain fittings (not included) per the manufacturer's instructions.
7. Apply 2 beads of waterbased adhesive caulk (not provided) on the bottom surface of the lavatory. Apply the first bead approx. 1/4" (6.35 mm) from the outside edge. Apply the second bead about 5/8" (15.875 mm) from the first bead. On basins with a narrow rim: Apply a bead of adhesive caulk on the bottom surface of the lavatory. See illustration.



FINISHING

8. Finish up the faucet and drain connections.
9. Run water into the lavatory and check for leaks.

Installation for Under-Counter Basins

NOTE: There is no template supplied with these basins

PREPARATION

1. Install the basic plumbing components: water inlet and drain
2. Determine the size of your opening based on the basin chosen. For example a basin with inside dimensions of 19¾" x 13" (Fig 1), will recommend a counter opening of 19½" x 12½" (Fig 2 & 3), ie ¼" less in both depth and length.

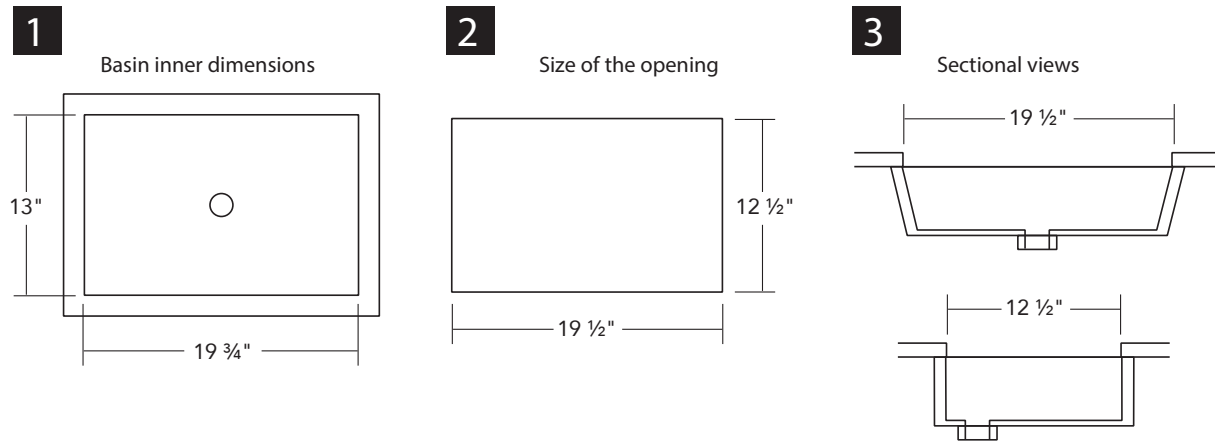

3. Install the basin drain. Read the manufacturer's instructions to ensure you are installing the equipment as you should. Before the final installation phases, check that all connections are waterproof.

INSTALLATION

To fix the basin under the counter:

4. Cover the flat rim of the basin with a water based adhesive caulk. Fig 4.
5. Place the basin underneath the counter and press up to ensure there is a good adhesion between the two surfaces that are touching. Fig 5.

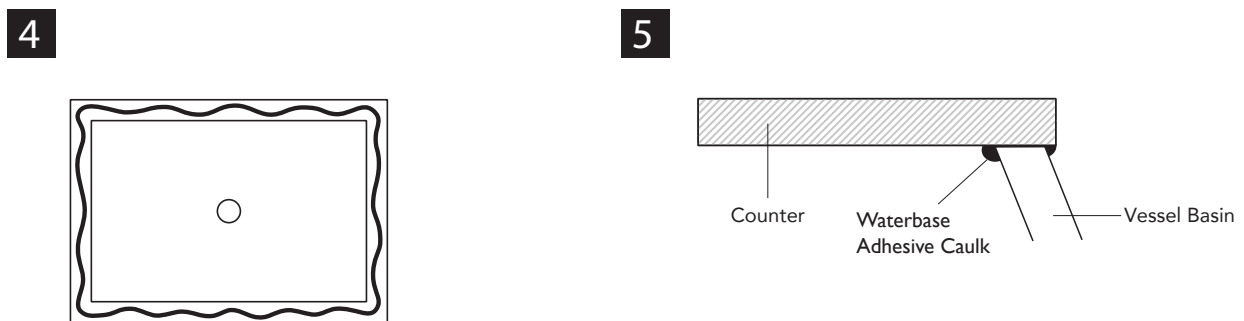

FINISHING

6. Position the lavatory squarely under the cutout and use a 'C' clamp to pressure and hold the basin securely to allow the adhesive to dry.

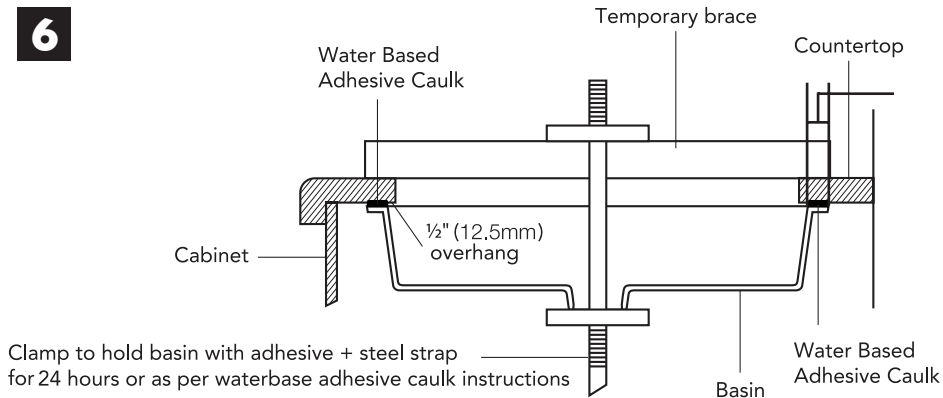

7. Install steel strapping or "L" brackets for extra support. Fig 6.

8. Wipe away excess sealant and fill any voids as necessary. Allow adhesive to set for 24 hours prior to use.

9. Connect the trap to the drain and complete faucet installation per manufacturer's specifications.

10. Run water into lavatory and check entire installation for leaks.

For additional fixing for ONLY the following models: SA0107N37, SA0107N38, SA0209N37, SA0209N38, SA0305N37 & SA0305N38

You may use the provided fixing bag set, but it is required to drill your countertop.

MODEL	mm	inches
SA0107N37	310	12 3/16"
SA0107N38	250	9 7/8"
SA0209N37	310	12 3/16"
SA0209N38	250	9 7/8"
SA0305N37	510	20 1/16"
SA0305N38	450	17 3/4"

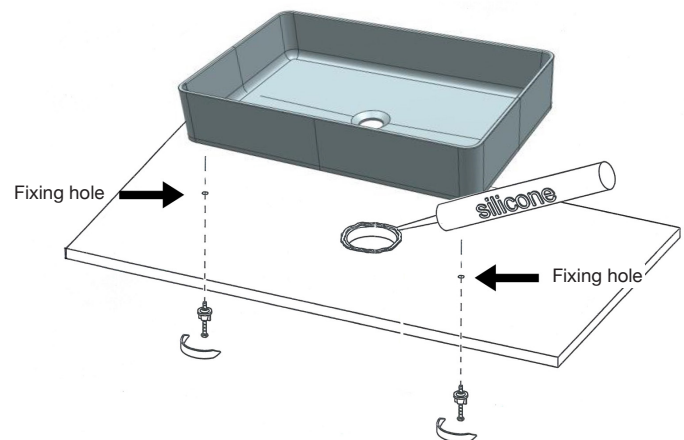

blu·stone™ cleaning & repair guide

blu·stone™ is Blu Bathworks' signature eco-friendly stone collection; a durable, low maintenance and hygienic material that is high pressure injection molded, non-porous and anti-microbial. blu·stone™ products are stain, scratch and impact resistant, and easy to clean: after each use, simply wipe with a soft cloth to remove any surface dirt.

routine care

- Never expose blu·stone™ to petroleum based products, such as paint removers, oven cleaners or other solvents (**Note:** personal hygiene products and cosmetics will NOT damage the surface)
- We recommend that stains are removed within 24 hours
- Do not directly cut on the blu·stone™ surface
- Blu Bathworks does not recommend exceeding US/ Canada maximum hot water temperature regulations of 150°F/65°C, respectively. Exceeding stated temperatures could result in damage to blu·stone™ products

standard cleaning

For standard cleaning of both gloss and matte finishes, we recommend using widely available cleaning products such as Mr. Clean, Fantastik, VIM, CIF etc. Matte finished products may occasionally require a mildly abrasive product.

blu·stone™ matte finish:

- For more difficult stains, use a mildly abrasive cream cleanser such as Soft Scrub, Comet Soft Cleanser, CIF or VIM

blu·stone™ gloss finish:

- Do not use abrasive products or cream cleansers

scratched or damaged surfaces

blu·stone™ matte finish:

- Ensure there is no surface dirt by flushing with water
- Rub the 600-grit sanding block, provided, in a gentle circular motion
- Higher grit sandpaper may be required to blend the repaired area to match the existing product finish

blu·stone™ gloss finish:

- Ensure there is no surface dirt by flushing with water
- We recommend sanding the area starting with 600, 800 and 1200-grit sandpaper: begin with the lower number (coarser) grit followed with each higher number (finer) in ascending order
- Finish by polishing the surface using a cloth and white polishing compound for automobiles

repairs

For more extensive repairs, send a photograph of your blu·stone™ product to Blu Customer Service (technical@blubathworks.com), who will inform you as to the most appropriate methods to use.

limited warranty

Blu Bathworks' ("Blu") warranty on blu·stone™ products covers all defects in materials and manufacturing for a period of five (5) years from the date of purchase. This limited warranty, starting on the original purchase date, is only offered to the original purchaser who acquires the product directly from Blu or from its authorized dealers. This limited warranty does not apply to cases in which a product was incorrectly installed, nor to damage due to negligence, misuse, thermal shocks, cigarettes, flames, natural catastrophes or other accidents. Blu is not responsible for costs and claims that may arise from purchase of a product unsuited to the structure of the existing building. Any transformation or alteration made to a Blu product automatically voids the warranty. Blu's warranty is limited to repair or replacement (with a product of equal value), provided the claim is made to an authorized dealer or directly to Blu, within the warranty period. Labor costs and any other expenses entailed by replacement of a Blu product are not covered by the warranty.