

51 M1 mirror

Installation Guide

series 600

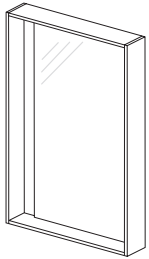

F51M1-0600

series 700

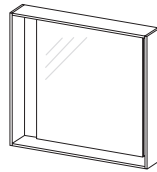

F51M1-0700

series 900

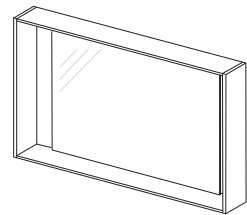

F51M1-0900

series 1200

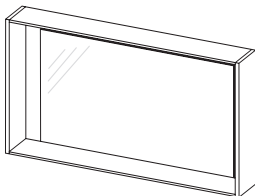

F51M1-1200

series 1400

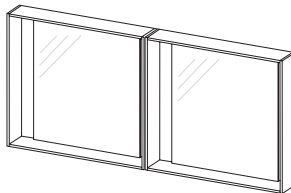

F51M1-1400

series 1800

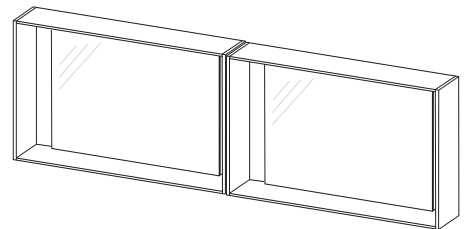

F51M1-1800

Attention - Before Installation

Thank you for choosing from among Blu's quality line of products. We recommend that you carefully read this installation guide to ensure your unit's proper operation and reliability for many years to come.

NOTE: Product is already optimized/preset for best drawer fitting - only minor adjustments may be needed. Adhere to all local building and plumbing codes. The diagrams in this guide are not construction plans. They are visual aids.

Installation Requirements

Please read the instructions carefully so as to avoid any damage to the fixture.

1. To ensure this product is installed properly, you must read and follow these guidelines.
2. The owner/user of the product must keep this information for future reference.
3. Consult local building codes to make sure the installation complies with standards.
4. Remove the unit from its packaging. Before disposing of it, inspect the unit to make sure its in good shape. Should inspection reveal any damage or defect in the finish, contact your distributor. The warranty does not cover damages or defects in the finish once it has been installed. Blu Bathworks' responsibility for shipping damages ceases upon delivery of the product in good order to the carrier. All complaints regarding damage due to transport must be made directly to the carrier.
5. Place the unit in the bathroom before you start working. Conserve all nuts and bolts.
6. To protect the unit during installation, we recommend that you lay a piece of cardboard on the bottom.
7. If the unit is covered with polyethylene protective film, do not remove until installation is complete to grant maximum protection. However, remove film where any two surfaces will be in permanent contact.
8. Verify that all dimensions on the plan are the same as the ones of the unit.

Installation Notes

Important! Install this product according to the installation guide.

Tools Required:



phillips screwdriver



level



drill

Materials Included:

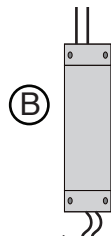

transformer

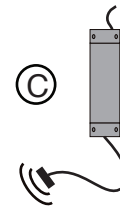

infrared (IR) switch

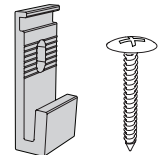

hanger & screw

Technical Support Assistance

If further assistance is required, please contact:

Product Support at 1.866.907.0122 (09:00 – 17:00hrs PST) or email technical@blubathworks.com

North America

Blu Bathworks Inc.

188 Smithe Street, Vancouver, BC, Canada, V6B 6A9

T +1.604.299.0122 F +1.604.299.0125

Please refer to blubathworks.com for warranty, terms & conditions under warranty & procedure for warranty service.

51 M1 Mirror Installation:

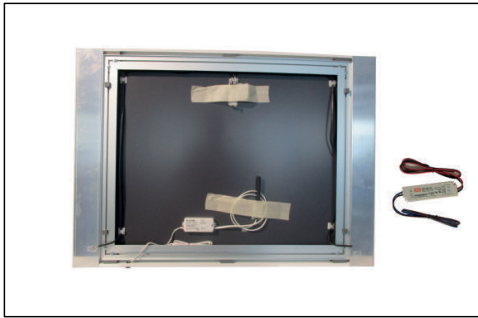

Kit on arrival

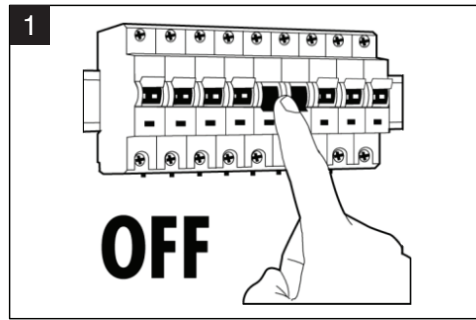

Disconnect electrical power from the main switchboard

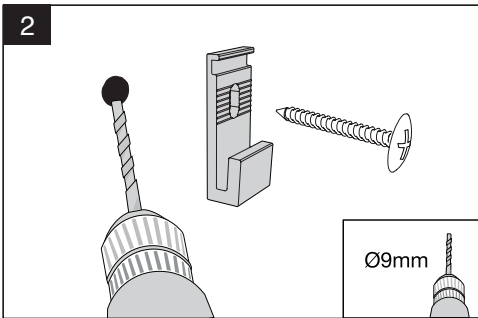

Fasten the metal hooks using a level

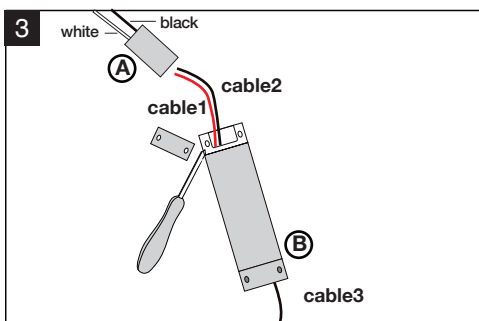
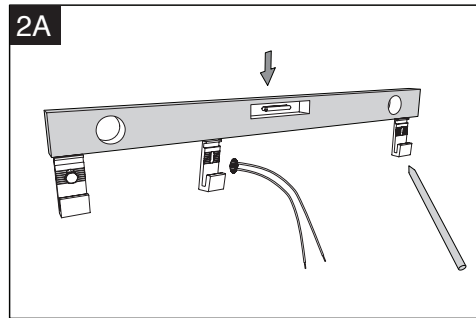

Connect cable (1) red / (2) black from the transformer (B) to the electrical box (A).

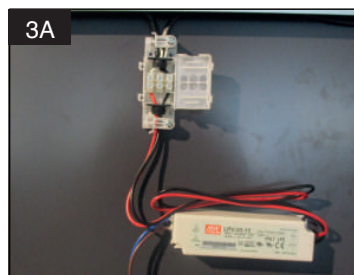

Now the black cable from the transformer (B) is connected with the black cable from the electrical box (A) and the red cable from the transformer (B) is now connected with the white cable from the electrical box (A).

51 M1 Mirror Installation continued:

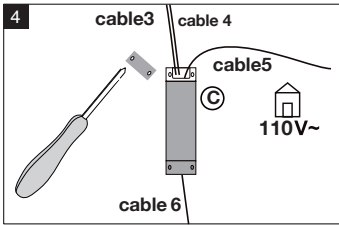

Open the infrared (IR) switch box (C)



Connect cable (3) blue / (4) brown from the transformer (B) to the infrared switch (C)

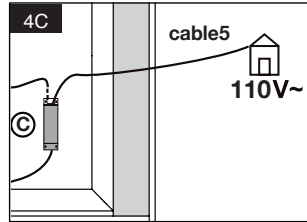

Connect the power cable (5) from the house to the infrared (IR) switch box (C)

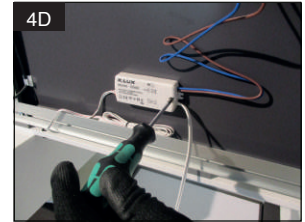

Close the infrared (IR) switch box (C)

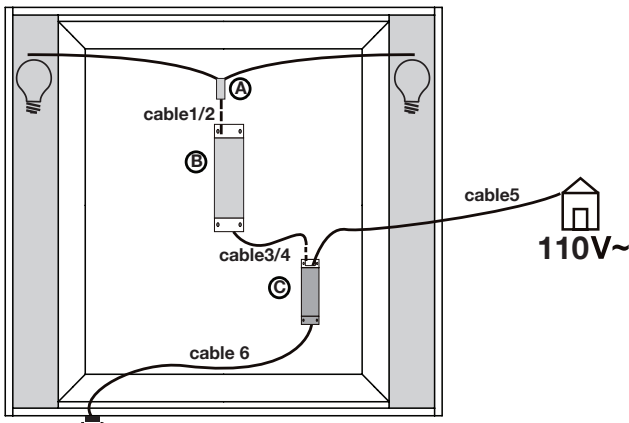

Infrared (IR) switch

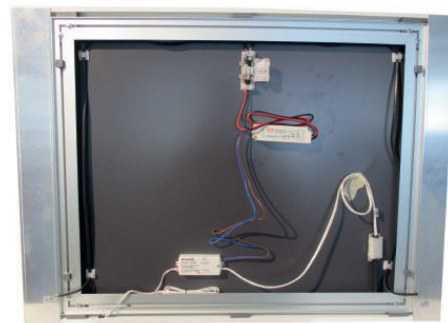

Mirror with active connections

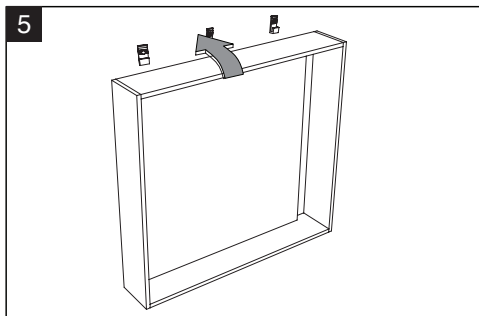

5

Install mirror making sure the wall hangers are perfectly attached to the mirror back frame channel using the provided metal hangers