

# BARIL

STYLE X FONCTION

Fiche Technique / Spec Sheet

## PRO-4395-05-xx

PRR-4395-05-xx\*

### Description

- Ensemble complet de douche thermostatique pression équilibrée
- Ensemble avec 3 accessoires
- Max : 7,6 l/min (2 gpm) - 80 psi (par accessoire)
- 17 l/min (4.5 gpm) pour 3 jets de corps
- Douchette 3 jets
- 2 accessoires peuvent fonctionner simultanément
- Le brut et la finition peuvent être commandé séparément :
  - Code du brut : RVA-9531-00-B ou RVA-9531-P0-B
  - Code de la finition seule : TRO-4395-05-xx ou TRR-4395-05-xx\*

*- Complete thermostatic pressure balanced shower kit*

- 3 accessories kit*
- Max: 2 gpm - 80 psi (per accessory)*
- 4.5 gpm for 3 body jets*
- 3-spray hand shower*
- 2 accessories can work together*
- The rough and the trim can be ordered separately:*
  - Rough code : RVA-9531-00-B or RVA-9531-P0-B*
  - Trim only code : TRO-4395-05-xx ou TRR-4395-05-xx\**

### Composantes incluses / Included components

- B05-9531-00-xx
- BRA-1614-04-xx
- RAC-9001-18-xx
- TET-1011-01-xx
- DGL-3070-53-xx
- BOD-5004-02-xx

### Finis disponibles / Available finishes

- CC: Chrome / *Chrome*
- KK: Noir mat / *Matte Black*
- LL: Laiton satiné / *Satin Brass*
- BB: Blanc / *White*
- GG: Or / *Gold*
- NN: Nickel brossé / *Brushed Nickel*
- YY: Nickel poli / *Polished nickel*
- VV: Cuivre satiné / *Satin copper*
- TT: Bronze vénitien / *Venetian bronze*

\* Avec raccord droit 6" du plafond (RAC-0618-44-xx)

\* With ceiling-mounted 6" straight pipe (RAC-0618-44-xx)



# BARIL

STYLE X FONCTION

Fiche Technique / Spec Sheet

B05-9531-00-xx

## Description

- Valve de douche thermostatique pression équilibrée avec dérivateur 3 voies complète (position partagée)
- Vous pouvez utiliser jusqu'à 2 accessoires à la fois
- Plaque mince de laiton
- Valves de service / anti-retour réversibles en cas d'inversion des arrivées d'eau
- Grande plage d'ajustement en profondeur
- Complete thermostatic pressure balanced shower control valve with 3-way diverter (shared port)
- Up to 2 accessories can be used at the same time
- Thin brass plate
- Reversible check / non-return valves in case of water supply inversion
- Large depth adjustment range

## Débit / Flow rate

- |                     |                      |
|---------------------|----------------------|
| 1 sortie / 1 exit:  | 2 sorties / 2 exits: |
| - 30 l/min - 60 psi | - 14 l/min - 60 psi  |
| - 7.9 gpm - 60 psi  | - 3.7 gpm - 60 psi   |

## Cartouche / Cartridge

- CAR-2661-00 (température / temperature), CAR-9531-03 (dérivateur / diverter)

## Finis disponibles / Available finishes

- |                                   |   |
|-----------------------------------|---|
| - CC: Chrome / Chrome             | - NN: Nickel brossé / Brushed Nickel    |
| - KK: Noir mat / Matte Black      | - YY: Nickel poli / Polished nickel     |
| - LL: Laiton satiné / Satin Brass | - VV: Cuivre satiné / Satin copper      |
| - BB: Blanc / White               | - TT: Bronze vénitien / Venetian bronze |
| - GG: Or / Gold                   |   |

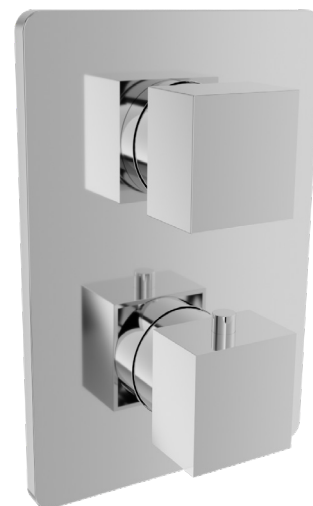

## Inclus / Included

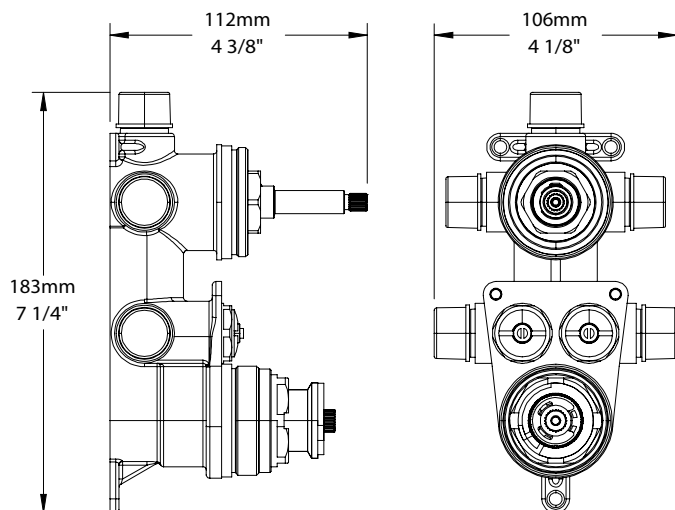

RVA-9531-00-B

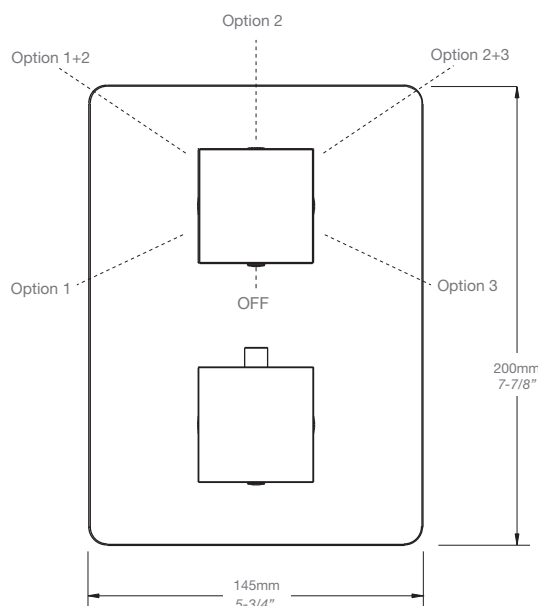

T05-9531-00-xx

STYLE × FONCTION

### Description

- Tête de douche moderne carrée 10" anti-calcaire en laiton
- Brass square modern 10" anti-limestone shower head

### Finis disponibles / Available finishes

- CC: Chrome / Chrome
- NN: Nickel brossé / Brushed Nickel
- KK: Noir mat / Matte black
- \*\*: Fini spécial / Special finish
- GG: Or / Gold

### Débit / Flow rate (pour option écologiques / for eco friendly options)

TET-1011-01-xx	TET-1011-01-xx-175	TET-1011-01-xx-150
- 7,6 l/min - 80 psi	- 6,6 l/min - 80 psi	- 5,7 l/min - 80 psi
- 2.00 gpm - 80 psi	- 1.75 gpm - 80 psi	- 1.50 gpm - 80 psi

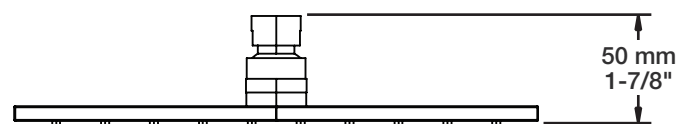
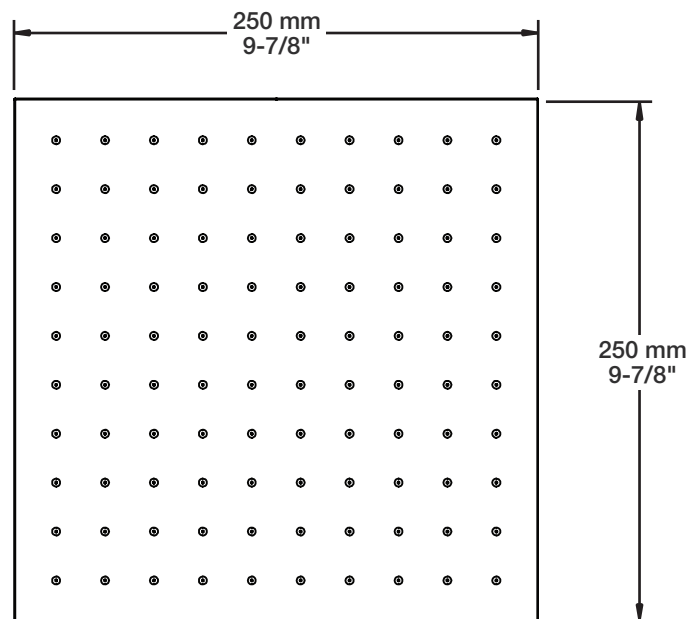
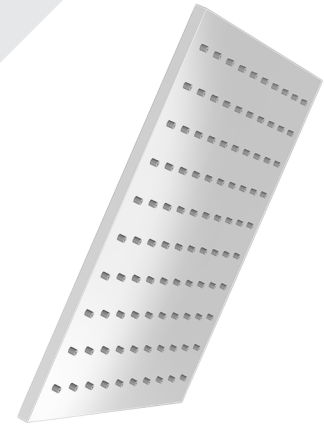

# BARiL

Fiche Technique / Spec Sheet

**BRA-1614-04-xx**

STYLE × FONCTION

## Description

- Bras de douche 16" avec rosace
- 16" shower arm with flange

## Finis disponibles / Available finishes

- CC: Chrome / Chrome
- NN: Nickel / Nickel
- GG: Or / Gold
- \*\*: Fini spécial / Special finish

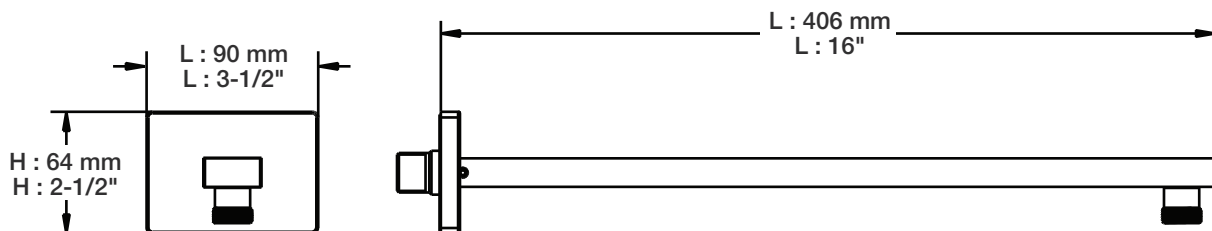

# BARiL

Fiche Technique / Spec Sheet

## DGL-3070-53-xx

STYLE × FONCTION

### Description

- Douche à glissière moderne 3 jets
- Mécanisme 3 jets : pluie, brume et mélange des deux
- 3-spray modern sliding shower bar
- 3-spray mechanism: rain, mist and mix of the two

### Finis disponibles / Available finishes

- CC: Chrome / *Chrome*
- NN: Nickel brossé / *Brushed Nickel*
- KK: Noir mat / *Matte Black*
- \*\*: Fini spécial / *Special finish*
- GG: Or / *Gold*

### Débit / Flow rate (pour option écologiques / for eco friendly options)

DGL-3070-53-xx	DGL-3070-53-xx-175	DGL-3070-53-xx-150
- 7,6 l/min - 80 psi - 2.0 gpm - 80 psi	- 6,6 l/min - 80 psi - 1.75 gpm - 80 psi	- 5,7 l/min - 80 psi - 1.5 gpm - 80 psi

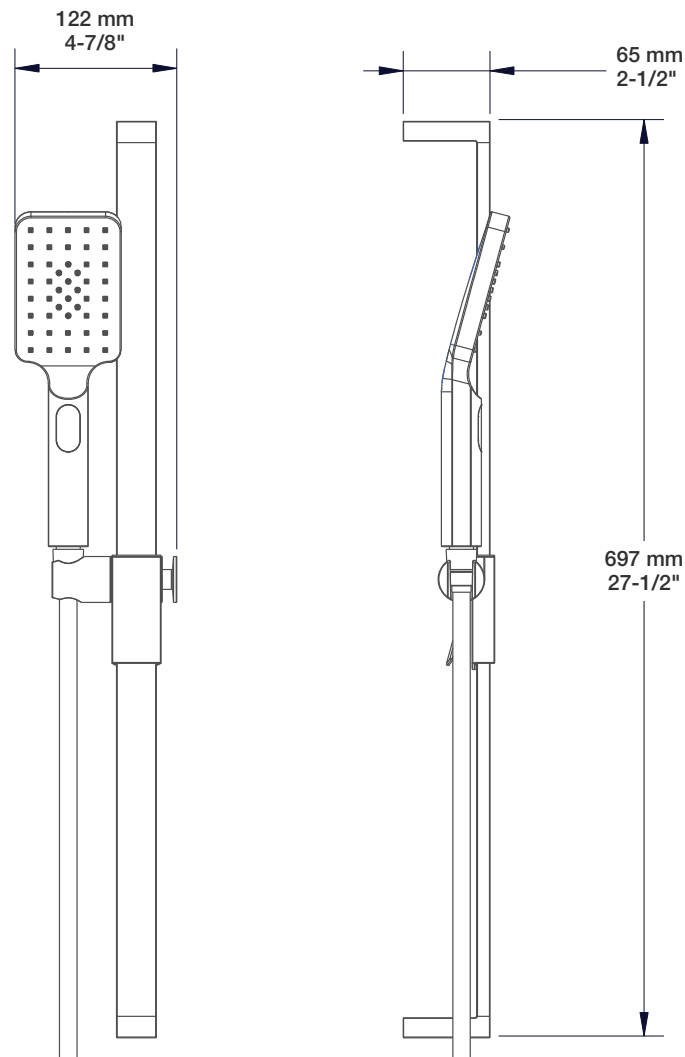

STYLE × FONCTION

### Description

- Coude de raccordement en laiton 1/2" F carré
- *Square 1/2" F brass elbow connector*

### Finis disponibles / Available finishes

- CC: Chrome / *Chrome*
- NN: Nickel / *Nickel*
- GG: Or / *Gold*
- \*\*: Fini spécial / *Special finish*

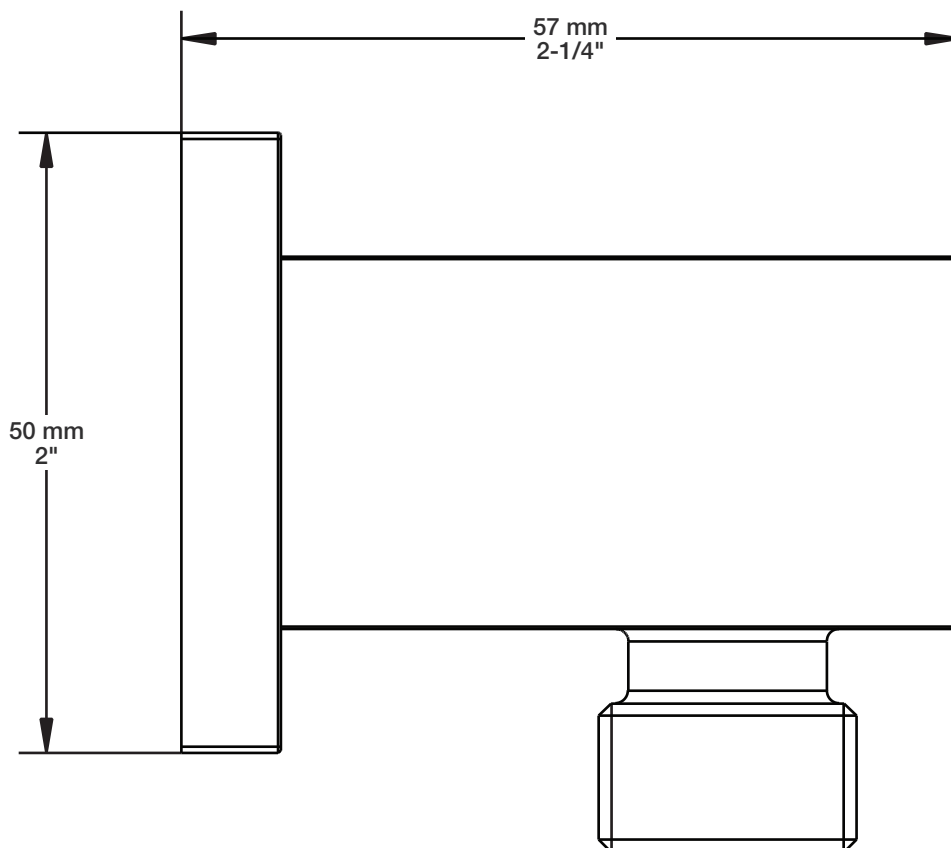

# BARIL

STYLE X FONCTION

Fiche Technique / Spec Sheet

## BOD-5004-02-xx

### Description

- Jet de corps latéral carré
- *Square lateral body jet*

### Débit / Flow rate

- 7,6 l/min - 80 psi
- 2 gpm - 80 psi

### Finis disponibles / Available finishes

- CC: Chrome / *Chrome*
- NN: Nickel brossé / *Brushed Nickel*
- KK: Noir mat / *Matte Black*
- GG: Or / *Gold*
- \*\*: Fini spécial / *Special finish*

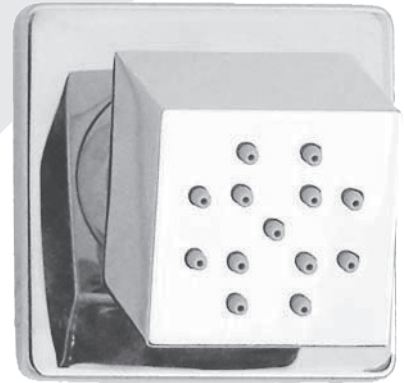

### Débit / Flow rate (pour option écologiques / for eco friendly options)

BOD-5004-02-xx	BOD-5004-02-xx-175	BOD-5004-02-xx-150
- 7,6 l/min - 80 psi	- 6,6 l/min - 80 psi	- 5,7 l/min - 80 psi
- 2.00 gpm - 80 psi	- 1.75 gpm - 80 psi	- 1.50 gpm - 80 psi

