

BARiL

Fiche Technique / Spec Sheet

B77-9560-03-xx-NS

STYLE × FONCTION

Description

- Dérivateur 3 voies avec arrêt
- 1 accessoire fonctionne à la fois
- 3-port diverter with stop
- 1 accessory works at a time

Débit / Flow rate

- 37 l/min - 60 psi
- 9.7 gpm - 60 psi

Cartouche / Cartridge

- CAR-9530-03-NS

Finis disponibles / Available finishes

- CC: Chrome / *Chrome*
- NN: Nickel brossé / *Brushed Nickel*
- KK: Noir mat / *Matte Black*
- **: Fini spécial / *Special finish*
- GG: Or / *Gold*



Inclus / Included

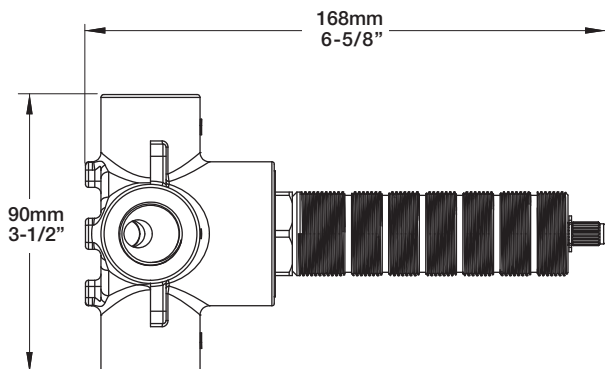

RVA-9563-00-NS-B

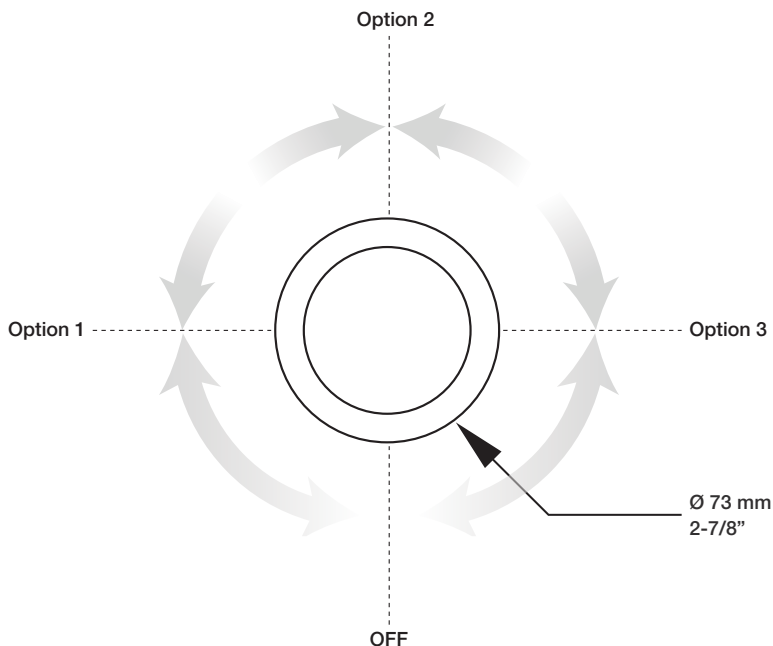

T77-9560-03-xx