

BARiL

Fiche Technique / Spec Sheet

B66-9520-00-xx-NS

STYLE × FONCTION

Description

- Valve de douche thermostatique pression équilibrée avec dérivateur 2 voies
- 1 accessoire fonctionne à la fois
- *Thermostatic pressure balanced shower control valve with 2-way diverter*
- *1 accessory works at a time*

Débit / Flow rate

- 32 l/min - 60 psi
- 8.5 gpm - 60 psi

Cartouche / Cartridge

- | | |
|------------------------------|---|
| Cartouche TP / TP cartridge: | Cartouche dérivatrice / Diverter cartridge: |
| - CAR-2661-00 | - CAR-9520-02-NS |

Finis disponibles / Available finishes

- | | |
|------------------------------|--------------------------------------|
| - CC: Chrome / Chrome | - NN: Nickel brossé / Brushed Nickel |
| - KK: Noir mat / Matte Black | - **: Fini spécial / Special finish |
| - GG: Or / Gold | |



Inclus / Included

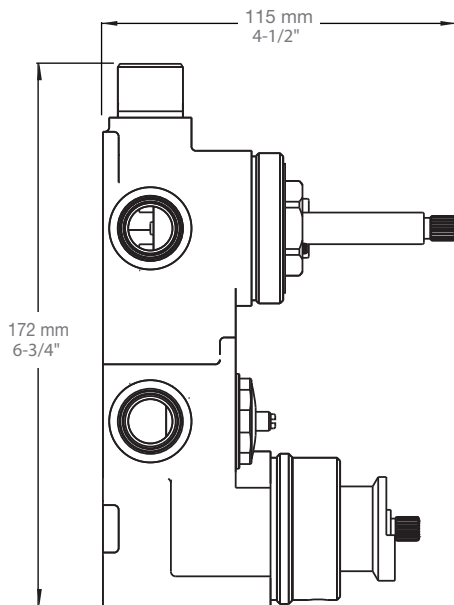

RVA-9520-00-NS-B

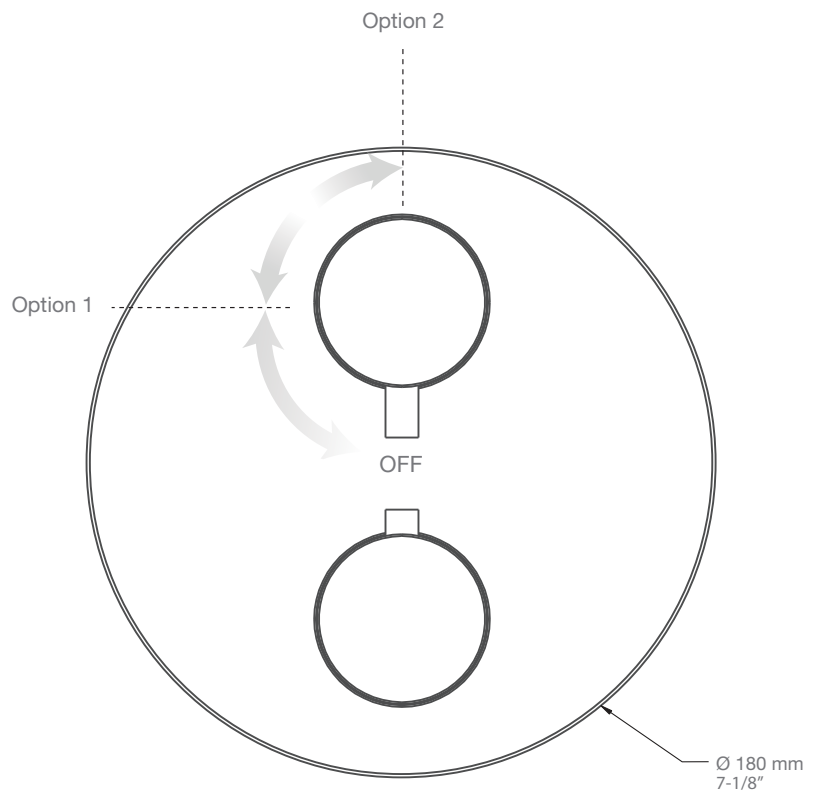

T66-9520-00-xx