

# BARiL

Fiche Technique / Spec Sheet

## B19-9560-03-xx

STYLE × FONCTION

### Description

- Dérivateur 3 voies avec arrêt
- Vous pouvez utiliser jusqu'à 2 accessoires à la fois
- 3-port diverter with stop
- Up to 2 accessories can be used at the same time

### Débit / Flow rate

- |                     |                      |
|---------------------|----------------------|
| 1 sortie / 1 exit:  | 2 sorties / 2 exits: |
| - 37 l/min - 60 psi | - 20 l/min - 60 psi  |
| - 9.7 gpm - 60 psi  | - 5.2 gpm - 60 psi   |

### Cartouche / Cartridge

- CAR-9530-03

### Finis disponibles / Available finishes

- CC: Chrome / *Chrome*
- NN: Nickel brossé / *Brushed Nickel*
- KK: Noir mat / *Matte Black*
- \*\*: Fini spécial / *Special finish*
- GG: Or / *Gold*



### Inclus / Included

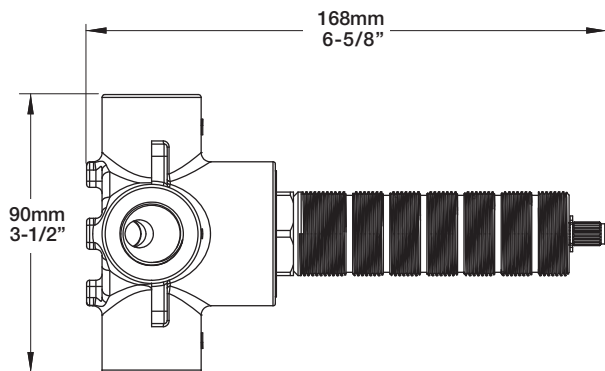

RVA-9563-00-B

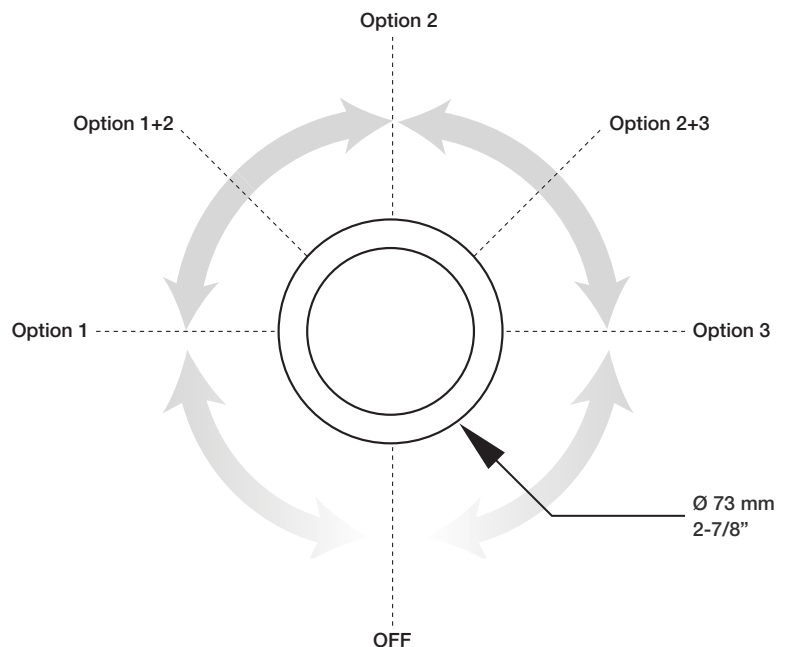

T19-9560-03-xx