

# BARiL

Fiche Technique / Spec Sheet

## B19-9560-02-xx-NS

STYLE × FONCTION

### Description

- Dérivateur 2 voies avec arrêt
- 1 accessoire fonctionne à la fois
- 2-port diverter with stop
- 1 accessory works at a time

### Débit / Flow rate

- 40 l/min - 60 psi
- 10.5 gpm - 60 psi

### Cartouche / Cartridge

- CAR-9525-02-NS

### Finis disponibles / Available finishes

- CC: Chrome / *Chrome*
- NN: Nickel brossé / *Brushed Nickel*
- KK: Noir mat / *Matte Black*
- \*\*: Fini spécial / *Special finish*
- GG: Or / *Gold*



### Inclus / Included

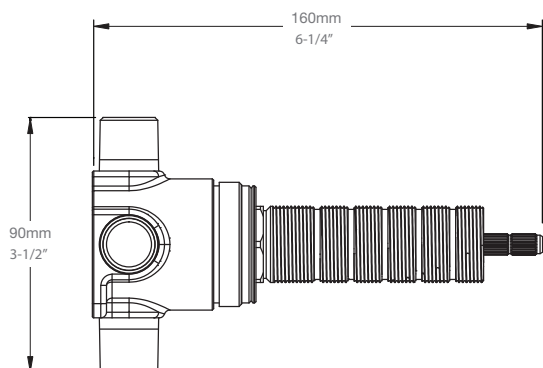

RVA-9562-00-NS-B

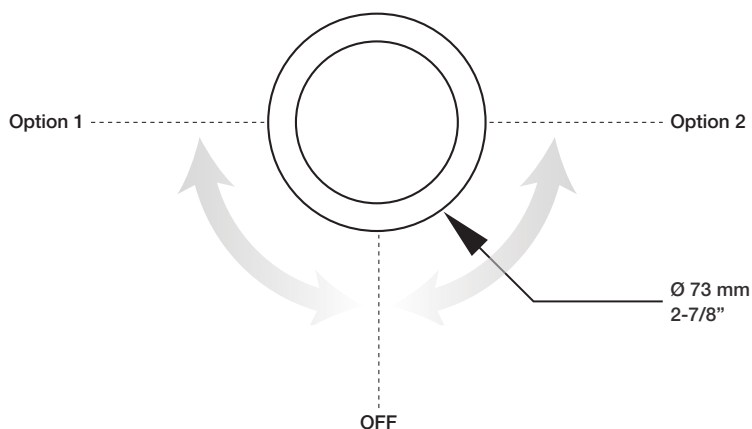

T19-9560-02-xx