

BARiL

Fiche Technique / Spec Sheet

B10-9530-00-xx

STYLE × FONCTION

Description

- Valve de douche thermostatique pression équilibrée avec dérivateur 3 voies
- Vous pouvez utiliser jusqu'à 2 accessoires à la fois
- *Thermostatic pressure balanced shower control valve with 3-way diverter*
- *Up to 2 accessories can be used at the same time*

Débit / Flow rate

- | | |
|---------------------|----------------------|
| 1 sortie / 1 exit: | 2 sorties / 2 exits: |
| - 32 l/min - 60 psi | - 16 l/min - 60 psi |
| - 8.5 gpm - 60 psi | - 4.2 gpm - 60 psi |

Cartouche / Cartridge

- | | |
|------------------------------|---|
| Cartouche TP / TP cartridge: | Cartouche dérivatrice / Diverter cartridge: |
| - CAR-2661-00 | - CAR-9530-03 |

Finis disponibles / Available finishes

- | | |
|------------------------------|--------------------------------------|
| - CC: Chrome / Chrome | - NN: Nickel brossé / Brushed Nickel |
| - KK: Noir mat / Matte Black | - **: Fini spécial / Special finish |
| - GG: Or / Gold | |



Inclus / Included

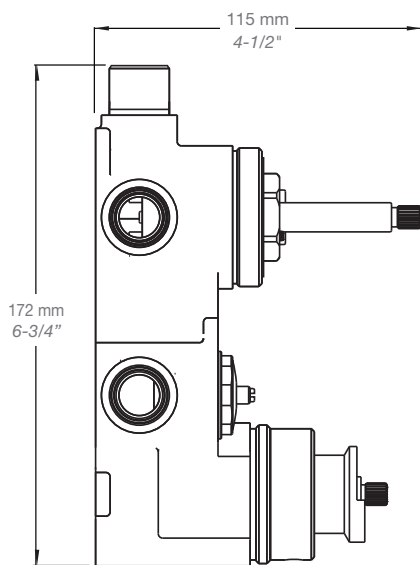

RVA-9530-00-B

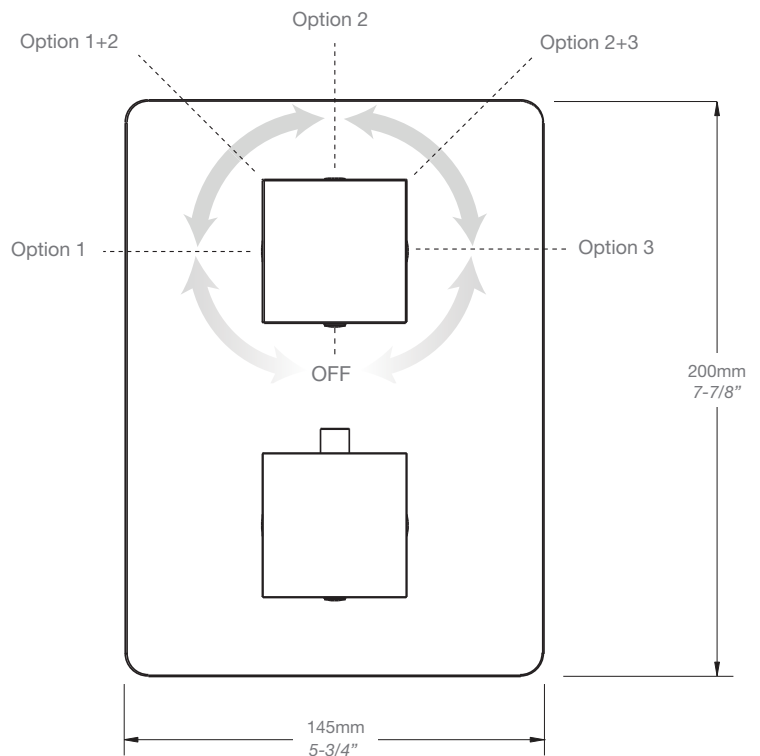

T95-9530-00-xx