

**MILAN  
66" ACRYLIC  
DOUBLE SLIPPER TUB**

Cat. No.  
ATDSN66B-WH-XX



L: 66-1/4"  
W: 30-1/4"  
H: 27-5/8"

Water depth: 16-1/2" to top of tub  
Water depth: 14" to overflow  
Overflow slot: 2-1/2" under tub rim  
Back of rim to center of drain: 15-5/8"

**The following is recommended for this tub:**

- Faucets: part #4022, 4025, or 4602
  - Rigid, freestanding Supplies: part #4502
  - Freestanding Filler: part #7902 or 7934
- (Do Not Need Bath Supplies)**

Gallon Capacity with OF: 63  
Shipping Weight: 160 lbs.  
Empty Weight: 115 lbs.  
Filled Weight with OF: 638 lbs.

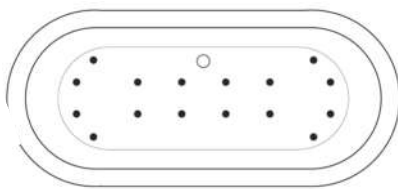

(Air jet configuration if system is added, more info on page 2.)

**Features:**

- ▶ Acrylic construction for lighter weight
- ▶ Double slipper tub
- ▶ Overflow slot with integrated drain
- ▶ Drain and overflow covers included (available in 7 finishes)
- ▶ 2" Rim
- ▶ No faucet holes
- ▶ Option to add foam insulation between tub walls available
- ▶ **New:** Air jet system now available, more info on page 2



**Finishes:**

- CP** Polished Chrome
- BN** Brushed Nickel
- ORB** Oil Rubbe Bronze
- PN** Polished Nickel
- WT** White
- PB** Polished Brass
- MB** Matte Black

**Custom Colors Available** (inside of tub is always white enamel):  
Painted bathtubs are considered "special order" and are not returnable  
\$160 Bisque or Black \$250 Designer Color

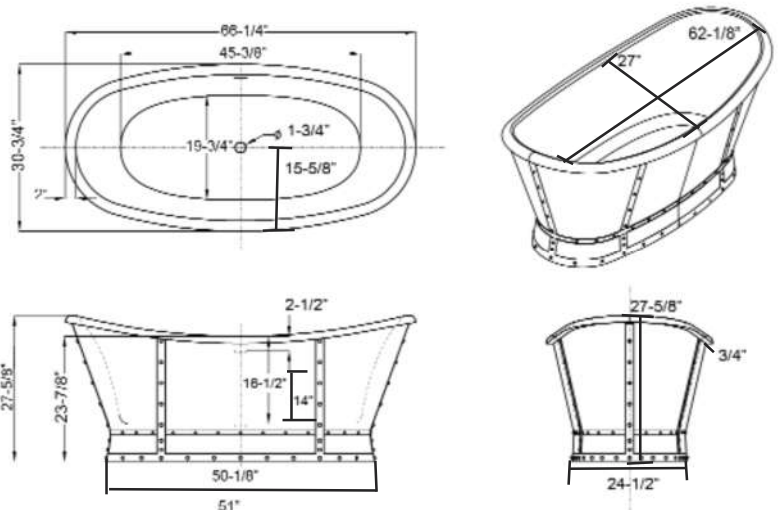

Dimensions of fixture are nominal and specifications subject to change without notice.

# BATHTUB AIR JET KIT

Cat. No.  
AIR KIT 1, AIR KIT 2

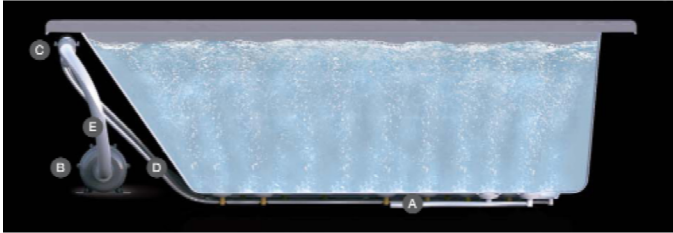

- A** AIR JET - Bottom air jets for maximum bubble action.
- B** BLOWER - The heart of the massage system.
- C** MANIFOLD - Double back flow security prevention device.
- D** FLEXIBLE PVC HOISING - IAPMO certified.
- E** MAIN AIR INTAKE HOSE - High temperature and pressure resistant.

## Features:

- ▶ 750 Watt blower motor operates system
- ▶ 300 Watt air heater warms air
- ▶ System powered by 120V
- ▶ 16 brass air jets placed in bottom of tub
- ▶ Each air jet has 24 holes
- ▶ Air jet caps available in white (AIR KIT 1) or black (AIR KIT 2)
- ▶ Includes 1 1/4" x 3' main air hose plus 1 1/4" x 9' extension hose
- ▶ Automatic system purge after each use
- ▶ Automatic safety timer turns off system after 20 minutes
- ▶ Includes water tight remote control
- ▶ Compatible with most acrylic, copper and resin tubs with no feet
- ▶ Not available with cast iron tubs or tubs with feet

Air Kit is installed in tub before shipment

## INSIDE TUB VIEW - WILL VARY BY TUB DESIGN



Air Jet



Remote

**Oval bathtub**  
Sample jet configuration

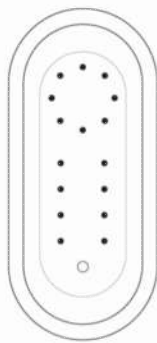

with end drain

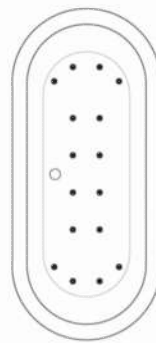

with center drain

**Rectangular bathtub**  
Sample jet configuration

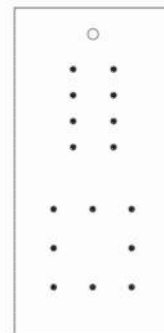

with end drain

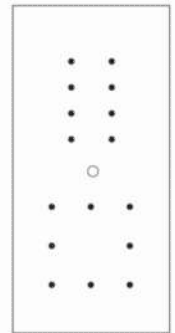

with center drain

**Round bathtub**  
Sample jet configuration

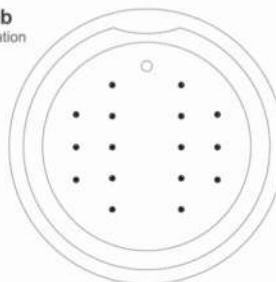

These diagrams are general representations.  
Jet placement may vary dependent on tub shape

### Features:

(16) Maxi Air Jets



Elbows for air jets



Tees for air jets