

**ONYX
56" ACRYLIC
OVAL TUB**

Cat. No.
ATOVN56FIG-XX



L: 55-3/8"
W: 29-1/2"
H: 26-7/8"

Water depth: 20-1/4" to top of tub
Water depth 17-1/8" to overflow
Overflow slot length: 1-3/4"
Center drain to back of rim: 12-3/8"
Bottom of drain to floor: 5-1/8"
Bathing well to floor: 6-1/8"

The following is recommended for ATOVN56F tubs:

- Faucets: part #4602,#4604 OR 7082
- Rigid, freestanding supplies: part #4502

Gallon Capacity	63
Shipping Weight:	153 lbs.
Empty Weight:	93 lbs.
Filled Weight	619 lbs.



For easier installation we recommend use of 5598-ITD Easy Install Rough In Kit

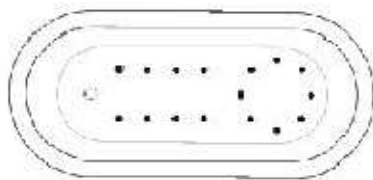

(Air jet configuration if system is added, more info on page 2.)

Features:

- ▶ Interior and exterior walls acrylic sheets
- ▶ Drain and overflow covers included (available in 6 finishes)
- ▶ Overflow slot with integrated drain
- ▶ Drain included
- ▶ Rim measurement: 1-3/4"
- ▶ Includes built-in adjusters
- ▶ Integrated seat increases comfort level
- ▶ No faucet holes
- ▶ Angle slope of tub: 25°
- ▶ Tub is thoroughly inspected before shipment
- ▶ IAPMO Certified
- ▶ Option to add foam insulation between tub walls available
- ▶ **New:** Air jet system now available, more info on page 2



Finishes:

- CP** Polished Chrome
- PB** Polished Brass
- PN** Polished Nickel
- BN** Brushed Nickel
- ORB** Oil Rubbed Bronze
- WT** White

Custom Colors Available (inside of tub is always white enamel):
Painted bathtubs are considered "special order" and are not returnable
\$160 Bisque or Black \$250 Designer Color

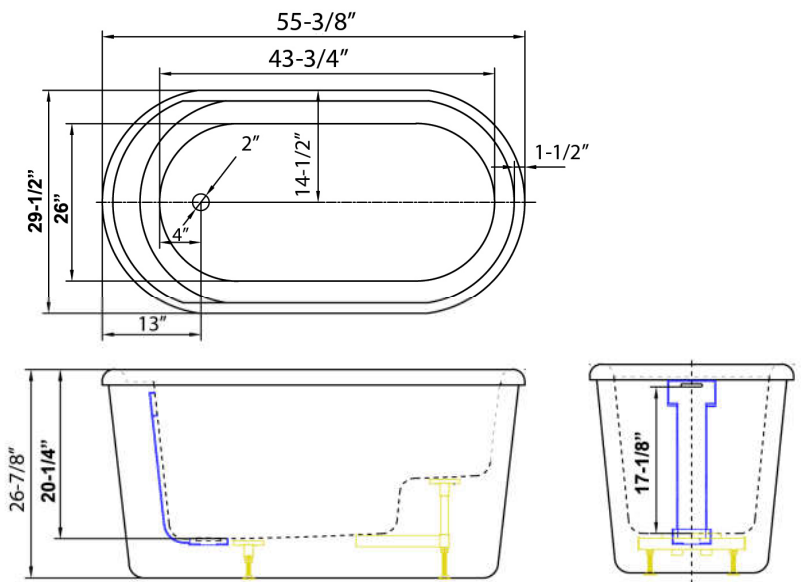

Dimensions of fixture are nominal and specifications subject to change without notice.

BATHTUB AIR JET KIT

Cat. No.
AIR KIT 1, AIR KIT 2



- A** AIR JET - Bottom air jets for maximum bubble action.
- B** BLOWER - The heart of the massage system.
- C** MANIFOLD - Double back flow security prevention device.
- D** FLEXIBLE PVC HOISING - IAPMO certified.
- E** MAIN AIR INTAKE HOSE - High temperature and pressure resistant.

Air Kit is installed in tub before shipment

Features:

- ▶ 750 Watt blower motor operates system
- ▶ 300 Watt air heater warms air
- ▶ System powered by 120V
- ▶ 16 brass air jets placed in bottom of tub
- ▶ Each air jet has 24 holes
- ▶ Air jet caps available in white (AIR KIT 1) or black (AIR KIT 2)
- ▶ Includes 1 1/4" x 3' main air hose plus 1 1/4" x 9' extension hose
- ▶ Automatic system purge after each use
- ▶ Automatic safety timer turns off system after 20 minutes
- ▶ Includes water tight remote control
- ▶ Compatible with most acrylic, copper and resin tubs with no feet
- ▶ Not available with cast iron tubs or tubs with feet

INSIDE TUB VIEW - WILL VARY BY TUB DESIGN



Air Jet



Remote

Oval bathtub
Sample jet configuration

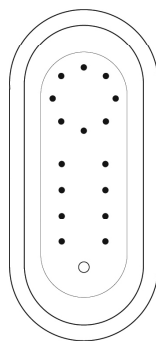

with end drain

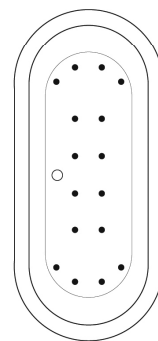

with center drain

Rectangular bathtub
Sample jet configuration

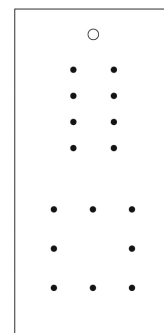

with end drain

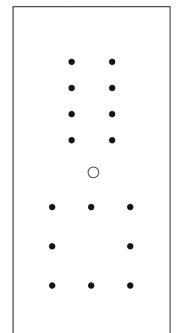

with center drain

Round bathtub
Sample jet configuration

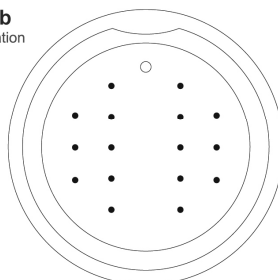

These diagrams are general representations.
Jet placement may vary dependent on tub shape

Features:

(16) Maxi Air Jets



Elbows for air jets



Tees for air jets