

BARiL

Fiche Technique / Spec Sheet

B66-9560-02-xx

STYLE × FONCTION

Description

- Dérivateur 2 voies avec arrêt
- Vous pouvez utiliser jusqu'à 2 accessoires à la fois
- 2-port diverter with stop
- Up to 2 accessories can be used at the same time

Débit / Flow rate

- | | |
|---------------------|----------------------|
| 1 sortie / 1 exit: | 2 sorties / 2 exits: |
| - 40 l/min - 60 psi | - 15 l/min - 60 psi |
| - 10.5 gpm - 60 psi | - 4 gpm - 60 psi |

Cartouche / Cartridge

- CAR-9525-02

Finis disponibles / Available finishes

- | | |
|------------------------------|--------------------------------------|
| - CC: Chrome / Chrome | - NN: Nickel brossé / Brushed Nickel |
| - KK: Noir mat / Matte Black | - **: Fini spécial / Special finish |
| - GG: Or / Gold | |



Inclus / Included

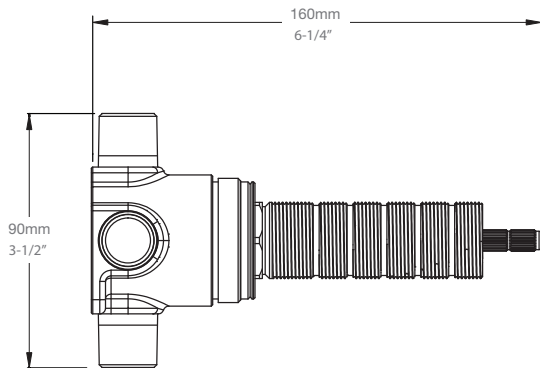

RVA-9562-00-B

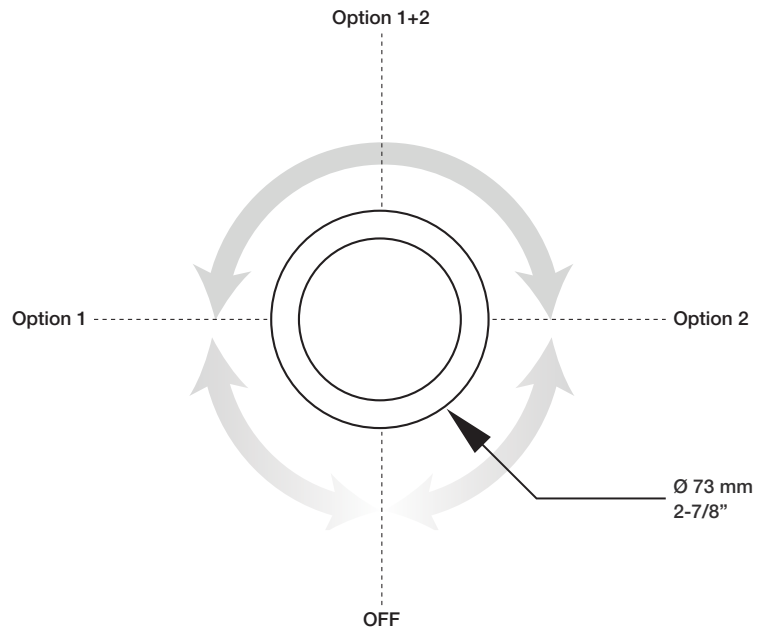

T66-9560-02-xx