

AXOR Edge
Single-Hole Faucet 130 - Diamond Cut, 1.2 GPM, without Pop-up Drain
 Finish: **chrome** Part no. : **46011001**



Description

Features

- Handle variant: Lever
- Spray modes: aerated spray
- Max. flow: 1.2 GPM (4.5 L/Min)
- Ceramic cartridge

Item details

List Price \$ 2,096.00

Technology



Compliance / Sustainability



Product image



Scale drawing

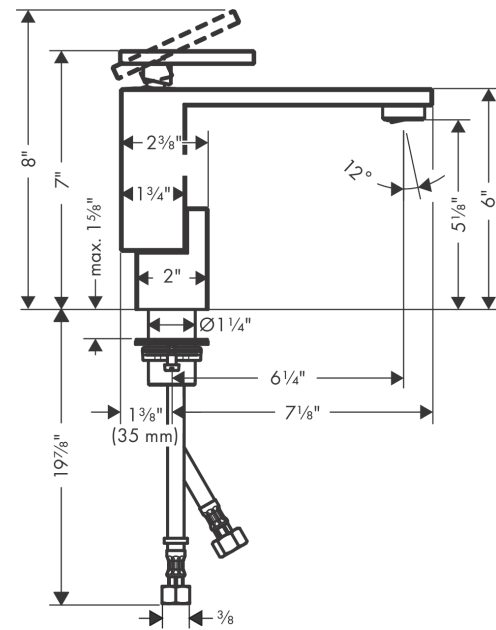

AXOR Edge
Single-Hole Faucet 130 - Diamond Cut, 1.2 GPM, without Pop-up Drain
 Finish: **chrome** Part no. : **46011001**



Exploded drawing

Year of production: >01/20

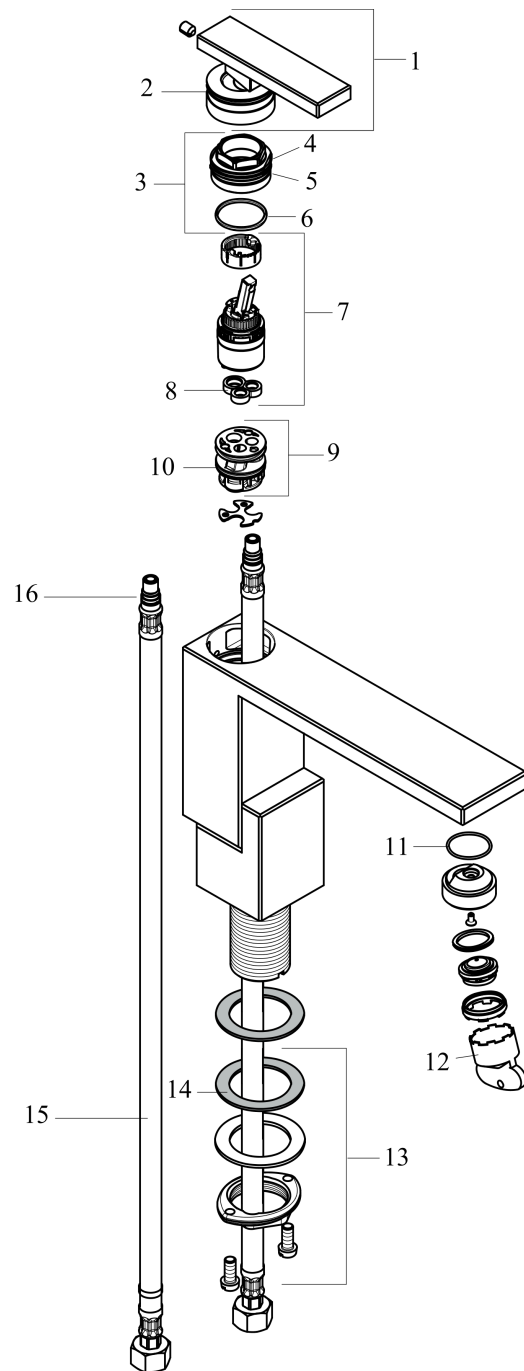

AXOR Edge

Single-Hole Faucet 130 - Diamond Cut, 1.2 GPM, without Pop-up Drain

Finish: **chrome** Part no. : **46011001**



Spare parts list

Year of production: >01/20

Pos.	Description	Part no.	Price	PU
1	handle	93422000	-	1
2	O-ring 33x1,5	98164000	-	1
3	nut	92926000	-	1
4	O-ring 30x1,5	98433000	-	1
5	O-ring 29x2	98391000	-	1
6	O-ring 25x1,5	98146000	-	1
7	cartridge, assy	92900000	-	1
8	seal	93383000	-	1
9	adapter for cartridge	98866000	-	1
10	O-ring 23x2	98398000	-	1
11	O-ring 22x1,2	98397000	-	1
12	service tool	95661000	-	1
13	fixing set (Ø 32)	13961000	-	1
14	lever collar	97548000	-	1
15	connection hose 35½" M8x0,75 3/8"	96316001	-	1
16	O-ring 7x1,5	98422000	-	1