

amerec

BLUECUBE +

'HIDE-AWAY' MEDIA PLAYER

for Bluetooth, USB, iPhone, iPod, MP3 devices and FM Radio

USER / INSTALLATION MANUAL



PLEASE READ THIS INSTRUCTION MANUAL BEFORE
INSTALLATION AND OPERATION

- 1 Getting Started 3
 - 1.1 Contents 3
 - 1.2 Connections..... 3
 - 1.3 12-pin Harness Connection..... 4
 - 1.4 Mounting the BlueCube+ Media Player..... 4
 - 1.5 Power On..... 5
 - 1.6 Remote Control Battery Install..... 5
 - 1.7 Remote Control Synchronizing..... 5
- 2 Location of Controls 6
 - 2.1 Wireless Handheld Remote Control..... 6
- 3 Listening to Devices..... 7
 - 3.1 Listening via USB..... 7
 - 3.1.1 iPhone & iPod Search..... 7
 - 3.1.2 Device Charging..... 7
 - 3.1.3 iPhone & iPod Compatible Models..... 8
 - 3.2 Listening via Bluetooth..... 8
 - 3.2.1 Pair with Bluetooth Device..... 8
 - 3.2.2 Listening via Bluetooth Device..... 8
 - 3.3 Listening via Auxiliary Input..... 8
 - 3.4 Adjust Volume Level..... 8
- 4 Listening to FM Radio 9
 - 4.1 Enter FM Radio Mode..... 9
 - 4.2 Scan or Seek FM Radio Channels..... 9
 - 4.3 Saving Radio Channel to Memory..... 9
 - 4.4 Listening to Saved Radio Memory..... 9
 - 4.5 Switch between US and European FM Modes..... 9
 - 4.6 Adjust Volume Level 9
- 5 Additional Features 10
 - 5.1 External 12V Trigger..... 10
 - 5.2 Connecting Multiple Amplifiers or High Current Lighting Systems..... 10
- 6 Specifications & Dimensions 11
 - 6.1 Specifications..... 11
 - 6.2 Dimensions..... 11
- 7 Warranty Information..... 12

1.1 Contents

- AQ-BC-5UBT BlueCube+ Media Player
- 2-Way RF Waterproof Remote Control
- Wiring Harness
- Four (4) Stainless Steel Mounting Screws
- One (1) CR2450 Battery
- Owner's Manual

1.2 Connections

1. 12-pin Watertight Harness

The 12-pin harness supplies power and ground connections to the BlueCube+ Media Player and four (4) speaker channel output connections from the BlueCube+ Media Player.

 Do not cut or modify the 12-pin harness on the unit side or warranty will be void.

2. FM Radio Antenna Jack

Connect antenna to female antenna receptacle. For best FM performance make sure the antenna is extended to the highest achievable position.

3. Auxiliary Outputs - Rear

Allows external amplifiers to be connected to power additional speakers.

4. Auxiliary Outputs - Front

Allows external amplifiers to be connected to power additional speakers.

5. Auxiliary Inputs

Connect to a portable audio player through the AUX IN cable on the back of the Digital Media Box.

6. 12V DC External Trigger

Allows for an external light or relay to be triggered (350mA max load)

7. USB Connector

Connect a USB device play music.

8. Wired Remote 8-pin DIN Cable

Connect to wired Remote Control.

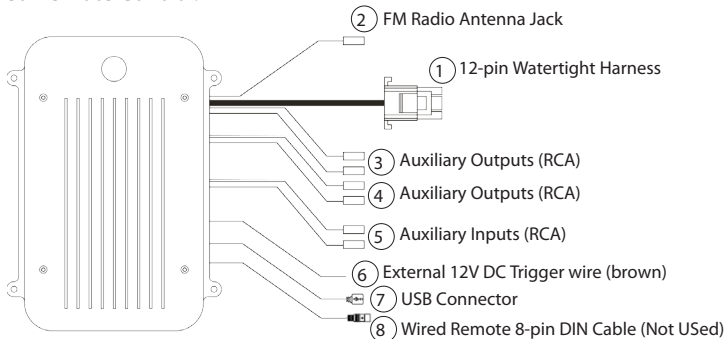

1.3 12-pin Harness Connection

The BlueCube+ includes the universal harness in order to connect the BlueCube+ to power and speakers.

All open wire connections should be soldered and protected against water and dust for best long term performance.

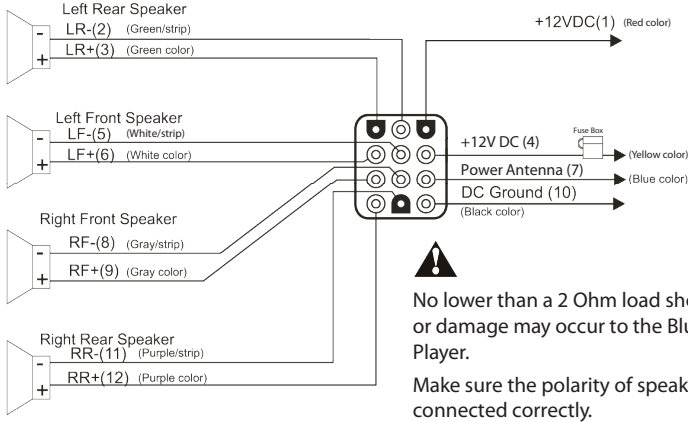

1.4 Mounting the BlueCube+ Media Player

1. Make sure the outside surface is clean and clear of debris.
2. The BlueCube+ Media Player has four (4) mounting screws. Drive the screws using a screw driver. Make sure screws are snug and do not over tighten.

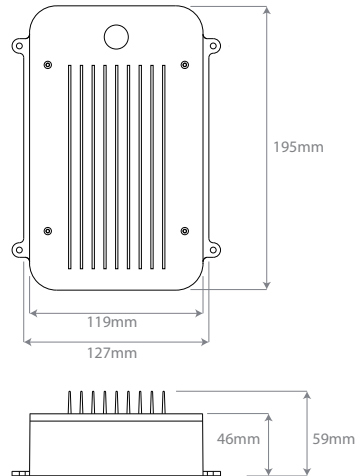

1.5 Power On

The BlueCube+ requires +12V DC to both the red and yellow wires. When both of these wires have power the BlueCoop+ is powered on and is indicated by a red LED on the harness grommet of the stereo.

In a spa application this requires the red and yellow wires to be jumped together and then connected to the +12VDC output of the power source. In this set up the BlueCube+ will always be on, with a very low current draw when idle.

In a boat, ATV or other application requiring power from a battery, the yellow wire (constant power) should be connected to the battery, and the red wire connected to the ignition or a switch.

1.6 Remote Control Battery Install

Remove the RF wireless remote control from the BlueCube+ Media Player box. Unscrew the waterproof cap on the back of the remote control. Place the CR24 50 battery in the RF remote control and replace the water/dust proof cap.

When the battery is installed, the remote control LCD should be solid and bright without any flickering.

1.7 Remote Control Synchronizing

The remote should already be paired from the factory, but if you need to re synchronize the remote follow the steps below.

1. Press the  POWER button on the remote control to turn on the remote.
2. The LCD will become illuminated and read 'NO LINK'.
3. Press and hold the MODE button for 5 – 10 seconds.
4. Once the remote has been paired, the LCD will display one of the audio modes (FM, USB, BT AUDIO).

For any additional remote controls, you will also need to activate/synchronize those remote controls by following the steps above.

 If the pairing process is not effective, check the battery voltage of the remote. If above 3V DC refer to section 1.5 above to make sure the battery is installed correctly. If battery voltage is below 3V DC replace the battery.

 If the LCD displays "NO LINK" in any mode, this means the remote is out of reception range or not paired correctly. Move the remote closer to the unit and try again.





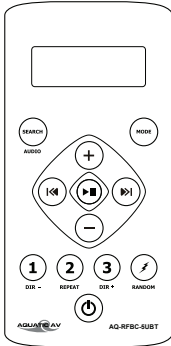

 If you lose your remote control and buy a new remote control, please follow the above to pair remote control.

2.1 Wireless Handheld Remote Control









Buttons	Music Mode: iPhone, iPod, Bluetooth, USB & MP3	FM Radio Mode
Power	Press once: Toggle from Operation mode to Standby mode or vice-versa.	
Mode	Press once: Change the source. Press and hold: Pair	Press once: Change the source. Press and hold: Pair
Search/Audio	Press once: NAVI search function Press and hold: Press and hold: Audio Menu (BAS-TRE-BAL-FAD-EUR-DX-MONO-STEREO)	Press once: Audio Menu (BAS-TRE-BAL-FAD-EUR-DX-MONO-STEREO)
Volume Up	Press once: Volume up Press and hold: Fast volume up	Press once: Volume up Press and hold: Fast volume up
Volume Down	Press once: Volume down Press and hold: Fast volume down	Press once: Volume down Press and hold: Fast volume down
Fast Rewind	Press once: Previous track Press and hold: Fast rewind	Press once: Scan down Press and hold: Toggle manual seeking
Fast Forward	Press once: Next track Press and hold: Fast forward	Press once: Scan up Press and hold: Toggle to manual seeking
12V Trigger / Random	Press once: Random playback Press and hold: Toggle 12V on/off	Press once: No function Press and hold: Toggle external 12V power on/off
Play/pause	Press once: Play/Pause Press and hold: no function	Press once: Toggle mute Press and hold: no function
1 / DIR-	Press once: Back to previous folder Press and hold: No function	Press once: Listen to FM preset station 1 Press and hold: Set preset FM station 1
2 / REPEAT	Press once: Repeat function Press and hold: No function	Press once: Listen to FM preset station 2 Press and hold: Set preset FM station 2
3 / DIR+	Press once: Forward to next folder Press and hold: No function	Press once: Listen to FM preset station 3 Press and hold: Set preset FM station 3

3.1 Listening via USB

2. Attach your device to the female USB socket the BlueCube+ Media Player using the appropriate USB adaptor. The USB input socket/extension is available (sold separately).
3. Press  (MODE) on the remote control to select USB mode.
4. Press  to Play/Pause.
5. Press  /  (FAST REWIND/FORWARD) to play previous/next song file.
6. Press  (REPEAT) to active repeat playback function
7. Press  (RANDOM) to active random playback function

 Always ensure to connect and disconnect your media player with dry hands!

3.1.1 iPhone & iPod Search

1. When using an iPhone or iPod, press  (SEARCH) to enter iPod searching mode.
2. Once in searching mode the remote will display 'Playlist'. Continue to press  (SEARCH) to scroll through the search modes below:
 - 1) Playlist 2) Artist 3) Album 4) Song 5) Genre 6) Composer 7) Audio Book
3. Press  (PLAY/PAUSE) To select the desired search mode.
4. Use  and  (Volume UP/DOWN) to scroll through your media in the selected search mode.
5. Once you find the desired media press  (PLAY/PAUSE) to make your selection. If your selection is a song it will begin to play, if you select a playlist, artist, album, genre, composer or audio book, the songs in the selected folder will be visible. Press  (PLAY/PAUSE) to play the desired song within the folder.

3.1.2 Device Charging

When specified USB devices are connected to the USB input the device battery will charge.

3.1.3 iPhone & iPod Compatible Models



iPhone 4
8GB 16GB 32GB



iPhone 4s
16GB 32GB 64GB



iPhone 5
16GB 32GB 64GB



iPhone 5c
16GB 32GB



iPhone 5s
16GB 32GB 64GB



iPhone 6
16GB 64GB 128GB



iPhone 6 Plus
16GB 64GB 128GB



iPod touch
4th generation
8GB 16GB 32GB 64GB



iPod touch
5th generation
16GB 32GB 64GB

3.2 Listening via Bluetooth

IAP Bluetooth connectivity allows device information, such as song, playlist and album titles, to be streamed wirelessly and viewable on the remote control.

3.2.1 Pair with Bluetooth Device

1. Switch on your Bluetooth device.
2. Select 'AQUATIC AV' from the list of available devices to pair (no password is needed).

i Only one Bluetooth device can be paired with the BlueCube+ Media Player at any time.

3.2.2 Listening via Bluetooth Device

1. Bluetooth mode will be activated once a Bluetooth device is paired.
2. Play the song from device and the sound will play through the BlueCube+ Media Player.
3. Press (PLAY/PAUSE) to play/pause the song.
4. Press / (FAST REWIND/FORWARD) buttons to play previous/next song file.
5. Track and volume can be controlled directly from your Bluetooth device, remote control or door controls.

3.3 Listening via Auxiliary Input

1. Connect your MP3 device to the RCA inputs.
2. Press (MODE) on the remote control to select 'AUX IN' mode.

i Only one Auxiliary input (RCA) can be used at any one time.

3.4 Adjust Volume Level

1. Press (VOLUME UP) once to increase the volume.
2. Press (VOLUME DOWN) once to reduce the volume.
3. Press and hold either or and the BlueCube+ Media Player will increase or decrease audio volume continuously.

4.1 Enter FM Radio Mode



1. Press  (MODE) on remote control to switch to FM radio mode.

i If this is the first time you listen to FM radio, the default frequency will be 87.5MHz, as shown on the remote LCD.

i FM radio is only available when you are in the FM Radio mode.



4.2 Scan or Seek FM Radio Channels

1. Press  (FAST REWIND) or  (FAST FORWARD) to seek another station.



2. Press and hold either  (FAST REWIND) or  (FAST FORWARD) for manual tuning back or forward.

i After using Seek mode the unit will automatically switch back into Scan mode after 20 seconds.

4.3 Saving Radio Channel to Memory

To save the current frequency into memory, press and hold ,  or  for more than 2 seconds. The station will be stored into relevant button.

4.4 Listening to Saved Radio Memory

Press the ,  or  preset button once to listen to the station stored in that button.

4.5 Switch between US and European FM Modes

1. Make sure the remote control is turned on and the BlueCube+ Media player is in 'RADIO' mode.

2. Press the AUDIO button 6 times in a row.

3. The remote will display 'AREA USA' or 'AREA EUR' depending on which tuning mode is currently selected.

4. Use the  and  buttons to switch between US or European modes.

5. Press  (PLAY/PAUSE) to select the desired tuning mode.

6. Once you switch modes it will default to the FM station stored in 'PRESET'.

i US mode will increase and decrease the FM frequency in steps of 0.1 MHz, e.g. 88.5, 88.6, 88.7 MHz. EUR mode will increase and decrease the FM frequency in steps of 0.05 MHz, e.g. 88.25, 88.30, 88.35 MHz.

i When in Seek mode and European FM tuning mode, all frequency steps will be visible.

4.6 Adjust Volume Level

1. Press  (VOLUME UP) once to increase the volume.

2. Press  (VOLUME DOWN) once to reduce the volume.

3. Press and hold either  or  and the BlueCube+ Media Player will increase or decrease audio volume continuously.

5.1 External 12V Trigger

Aquatic AV understands the need for more flexible remote applications. With the BlueCube+ Media Player Aquatic AV has provided an independent 12V 'accessory' trigger, activated from the RF wireless remote. This could activate any 12V based device like 12V lights or 12V motors.

In any operational mode, press the  (12V TRIGGER) key to activate. Press again to deactivate.

 Aquatic AV strongly recommend you speak to our technical service staff or your local Aquatic AV dealer if you are considering using this feature.

 Load on External Trigger should not exceed 350mA.

5.2 Connecting Multiple Amplifiers or High Current Draw Lighting Systems

Wiring a Single Pull Single Throw (SPST) Relay

The SPST is necessary to protect the stereo in systems with multiple amplifiers. The remote and trigger wire provide 350mV. While this enough to power a single amplifier, complex systems with multiple amplifiers will require a SPST relay.

Position 30: requires 12VDC from the main power source (12V battery, power supply etc). This should be the same power source that is powering your stereo.

Position 85: this is where you connect your ground from your power source (12V battery, power supply, etc.) This should be the same ground reference as your stereo.

Position 86 : position 86 is triggered 12V, and is sent when your stereo is powered on.

Position 86 can be connected to either the blue remote wire in the harness or the brown 12V trigger on the rear of the unit. The differences are below:

Blue (recommended): The blue (remote wire) provides a 12VDC output when the stereo is powered on. Meaning as soon as the stereo is powered on the blue wire sends 12VDC through the relay powering on the amplifier.

Brown: the brown (12V Trigger) provides 12VDC output when it is triggered via the lightning bolt icon on the faceplate or handheld remote. This setup is more advantageous in a more complex system with several zones, as it gives you control of when an amp is on or off.

Position 87: this is the 12VDC output that you will provide 12VDC to the remote turn on to the amplifiers in your system.

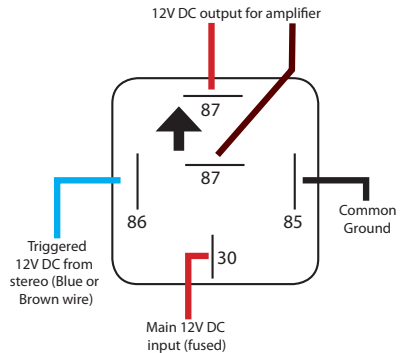

6.1 Specifications

Media	
Supported media.....	A2DP & IAP Bluetooth/USB/iPod/iPhone/MP3/FM/AUX
Device charging.....	via USB
Device control.....	via RF Remote Control or Wired Remote Control
Inputs	
USB.....	USB 2.0
Auxiliary.....	1x stereo pair RCA input
Outputs	
Pre-Out.....	2x stereo pair RCA (4V)
FM Radio	
FM pre-sets.....	3
US/Euro frequencies.....	Yes
Power	
Output voltage @ 2 Ohm.....	4x 72W
Output voltage @ 4 Ohm.....	4x 45W
Operation voltage.....	9.6V - 14.4V DC
Max current draw.....	7A
Standby current draw.....	6mA
Multi-Environment Certifications	
Waterproof / Dustproof.....	Yes IP65 (Remote Control rated IP66)
Conformal PCB coating.....	Yes
UV protection.....	500 hours stable, ASTM D4329 compliant
Salt/Fog protection.....	500 hours stable, ASTM B117 compliant
Stainless Steel mountings.....	Yes

6.2 Dimensions

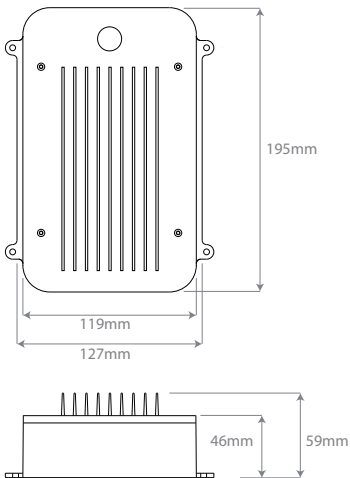

For assistance, contact:

amerec

P.O. Box 2258, Woodinville, WA 09872

Phone 1-800-363-0251

1-425-951-1120

Fax 1-425-951-1130

eMail Support@amerec.com

FCC ID:
MADE IN CHINA

This device complies with Part 15 of the FCC Rules. Operation is subject to the following two conditions: (1) this device may not cause harmful interference, and (2) this device must accept any interference received, including interference that may cause undesired operation.

NOTE:

The equipment has been tested and found to comply with the limits for a Class B digital device, pursuant to Part 15 of the FCC Rules. These limits are designed to provide reasonable protection against harmful interference in a residential installation. This equipment generates, uses and can radiate radio frequency energy and, if not installed and used in accordance with the instructions, may cause harmful interference to radio communications. However, there is no guarantee that interference will not occur in a particular installation.

If this equipment does cause harmful interference to radio or television reception, which can be determined by turning the equipment off and on, the user is encouraged to try to correct the interference by one or more of the following measures:

- Reorient or relocate the receiving antenna.
- Increase the separation between the equipment and receiver.
- Consult the dealer or an experienced radio/TV technician for help.

The manufacturer is not responsible for any radio or TV interference caused by unauthorized modifications to this equipment. Such modifications could void the user authority to operate the equipment.

iPhone, iPod and iPod Touch are trademarks of Apple Inc., registered in the U.S. and other countries.

Made for iPod and Made for iPhone mean that an electronic accessory has been designed to connect specifically to iPod or iPhone respectively, and has been certified by the developer to meet Apple performance standards. Apple is not responsible for the operation of this device or its compliance with safety and regulatory standards. Please note that the use of this accessory with iPod or iPhone may affect wireless performance.

Product design and specification subject to change without notice. E&OE.

Doc V3.1

