

MODEL NUMBER:

■ 8337.230 - Toilet Tissue Holder

Available Finishes

.002	Polished Chrome
.224	Oil Rubbed Bronze
.295	Satin Nickel (PVD)

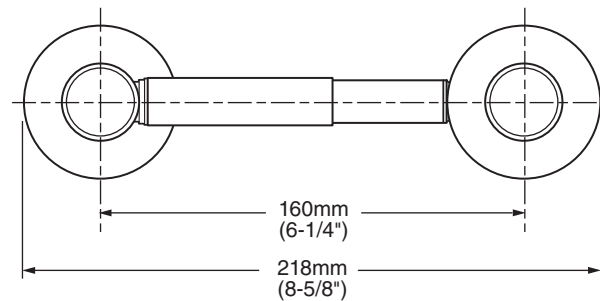
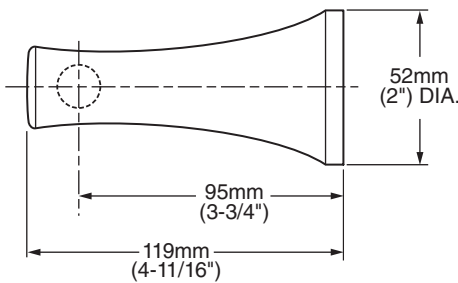

PRODUCT FEATURES:

Materials of Construction: Metal construction for durability & long life.

Concealed Mounting: No exposed set screws.

Easy to Install

Durability of Finishes: Chrome and PVD finishes will never tarnish.

SUGGESTED SPECIFICATION:

Toilet Tissue Holder shall feature metal construction with tarnish - free PVD finish. Shall feature concealed mounting with no exposed set screws. Toilet Tissue Holder tube shall be Brass tube. Toilet Tissue Holder shall be American Standard Model # 8337.230.____.

American Standard

Style That Works Better
