

SELECTRONIC® SENSOR-OPERATED URINAL FLUSH VALVE, 1.0 GPF BATTERY POWERED



GENERAL DESCRIPTION:

Exposed, sensor-operated Selectronic® Urinal Flush Valve for 3/4" top spud urinals. CR-P2 lithium battery powered.

PRODUCT FEATURES:

- **Factory-Installed CR-P2 Lithium Battery**
- **Pressure Compensation** feature ensures accurate flush volume regardless of inlet water pressure
- **Self-Cleaning Piston** with integral wiper spring significantly reduces clogging and maintenance
- **Selectronic® Proximity System** with universal sensor provides hygienic, "hands free" operation
- **State-of-the-Art Electronics** prevent ghost flushing
- **Dezincification Resistant** semi-red brass alloy
- **Fully Mechanical Manual Override Button** can flush the valve without power
- **Fail-Safe:** Valve automatically closes upon loss of power or water pressure and does not need to be reset
- **Adjustable Sanitary Flush** cleans the fixture & maintains the trap seal.
- **Stadium Feature:** Valve automatically switches to water savings mode during periods of heavy usage
- **Chemical Resistant EPDM Seals** for extended life
- **High Back Pressure Vacuum Breaker**
- **Adjustable Tailpiece**
- **Range can be adjusted manually or with optional remote control**
- **No external volume adjustment.**
- **Can be installed left or right handed**

MODEL NUMBER:

- ❑ **6063.101.002** Exposed, sensor-operated flush valve for 3/4" top spud urinals, 1.0 gpf.
Inlet includes 3/4" sweat solder kit and angle stop with back flow protection and vandal-resistant cap.
Outlet includes 3/4" high back pressure vacuum breaker with spud coupling and flange.
- ❑ **6063.510.002** Retrofit Valve Only, 1.0 gpf

OPERATING PRESSURE:

20 psi (flowing) - 80 psi (static)

FLOW REQUIREMENT:

10 gpm (37.9 L/min.)

BATTERY LIFE:

4 years

OPTIONAL ACCESSORY:

- Cast wall flange with set screw (6065816.002)
- 12-1/2" long vacuum breaker (M964446-0020A)
- 4" longer than standard

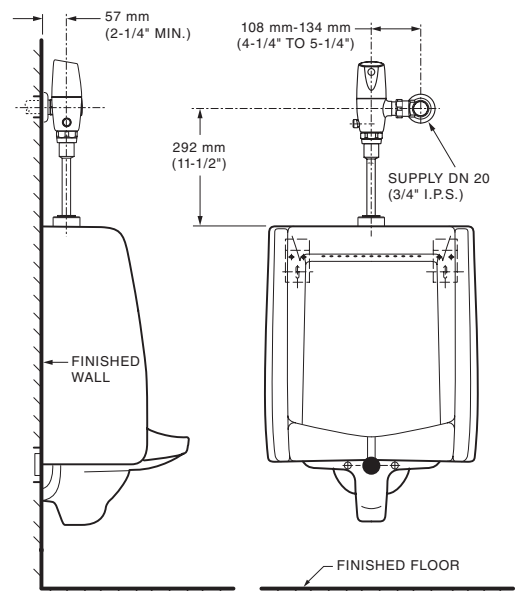

RECOMMENDED SPECIFICATION:

Electronic, sensor activated urinal flush valve shall feature self-cleaning piston valve with integral wiper spring in refill orifice to prevent clogging. Includes a factory-installed CR-P2 lithium battery and fully mechanical manual override that can flush the valve without power. Includes semi-red brass valve body and metal cover with chrome finish. Includes angle stop with back-flow protection & vandal-resistant cap. Sweat solder kit and high back pressure vacuum breaker also included. 1.0 gpf / 3.8 Lpf flush valve shall be American Standard Model # 6063.101.002.

LISTINGS:

- ASSE 1037
- ANSI/ASME A112.19.2
- ADA Compliant

Roughing-in Dimensions

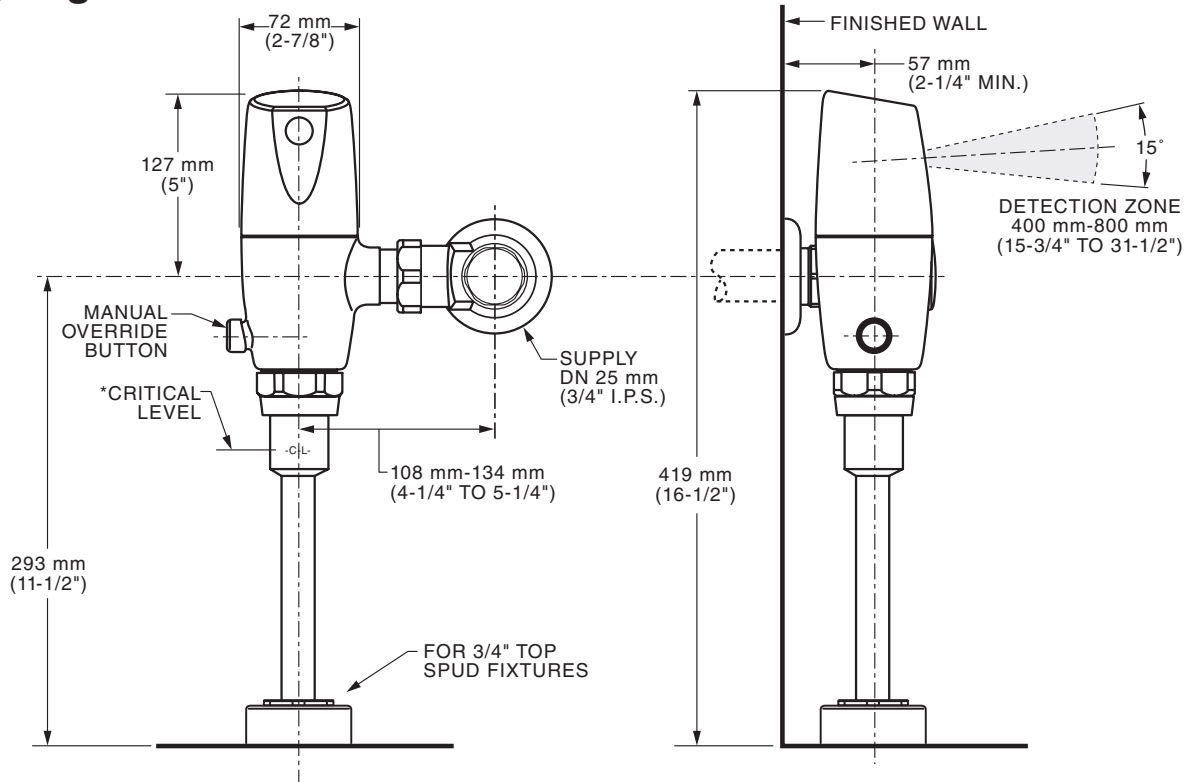

*Note: The Critical Line (-C-L-) on Vacuum Breaker must typically be 6" (152mm) above fixture. Consult Codes for details.

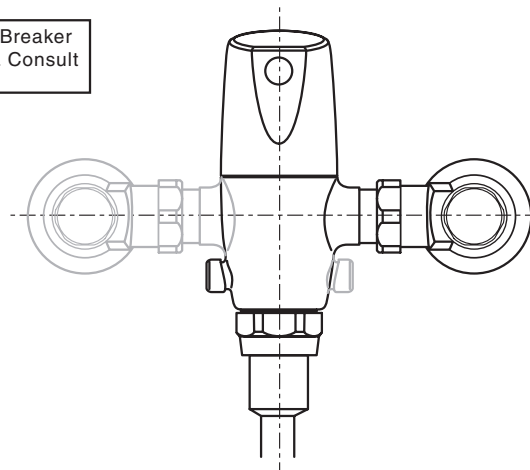

Right or Left Hand Installation

 MEETS THE AMERICANS WITH DISABILITIES ACT GUIDELINES AND ANSI A117.1 REQUIREMENTS FOR ACCESSIBLE AND USABLE BUILDING FACILITIES-CHECK LOCAL CODES

PART OF **LIXIL**