

**CULINAIRE COLLECTION™  
STAINLESS STEEL  
KITCHEN SINKS**

MODELS 7501.103, 7502.103, 7502.403,  
7504.103, 7507.103, 7510.103

**SELF RIMMING**

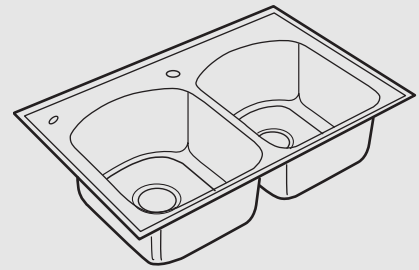

Certified to comply with ANSI A112.19.3M  
CAN/C.S.A. B-45  
Observe local plumbing and building codes.

**Thank you for selecting American-Standard...the benchmark of fine quality for over 100 years. To ensure that your installation proceeds smoothly--please read these instructions carefully before you begin.**

790767-100

**BEFORE YOU BEGIN...**

Unpack new sink and inspect carefully for damage. Replace the sink in its original packing carton to protect it until you are ready to begin installation.

**Recommended Tools & Materials**

- |   |                          |
|---|--------------------------|
| Putty Knife   | Basin Wrench             |
| Pipe Wrench   | Saber Saw                |
| Channel Locks                                       | Plumber's Putty or Caulk |
| Long Phillips Screwdriver<br>or Regular Screwdriver | Tubing Cutter            |
| Adjustable Wrench                                   | Tape Measure             |
| Drill   | Hacksaw                  |
|   | Mineral Spirits          |
|   | Silicone Sealant         |

**CUTOUT DIMENSIONS FOR SINKS:**

Below are the dimensions needed to determine the cutout size for each sink. Select the correct diagram for your sink and refer to the instructions below.

Locate and mark center lines of sink on countertop.

Provide proper clearance under the countertop for the faucet supply lines and the structural parts of the cabinet.

By using the diagrams below and measuring your sink, draw the outline of the sink cutout onto the countertop. This is the cutting outline.

Remember that the size of the sink is larger than the cutout.

**Countertop Cutout Dimensions**

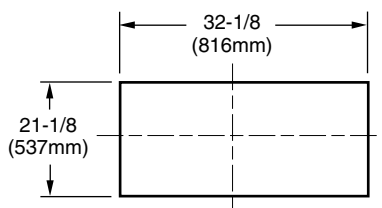

**CULINAIRE DOUBLE BOWL SINK  
MODEL 7502**

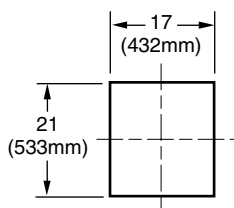

**CULINAIRE ISLAND SINK  
MODEL 7507**

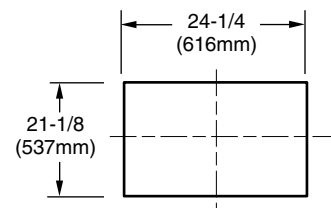

**CULINAIRE SINGLE BOWL SINK  
MODEL 7501**

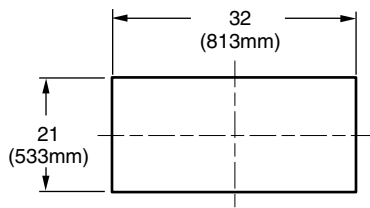

**CULINAIRE DUAL LEVEL  
BOWL SINK  
MODEL 7504**

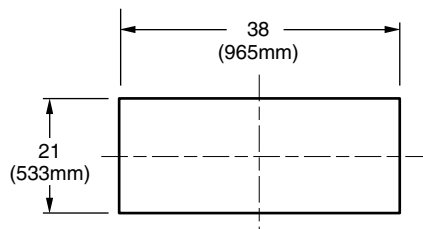

**CULINAIRE DUAL LEVEL SINK  
WITH DRAIN BOARD  
MODEL 7510**

**IMPORTANT: DIMENSION OF FIXTURES ARE NOMINAL AND MAY VARY WITHIN THE RANGE OF TOLERANCES ESTABLISHED BY A.N.S.I. AND C.S.A. STANDARDS.**

## AFTER THE CUTOUT IS DRAWN...

**1**

Drill a clearance hole inside the cutout line as marked on the countertop.

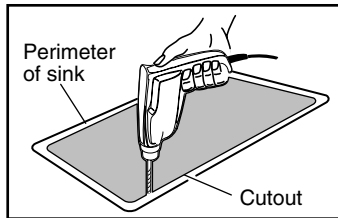

**2**

Cut opening on cut line inside the perimeter of sink. **Note** - Formica countertop installation only is illustrated. Contact your countertop distributor for the best method of cutting other materials such as marble, hard synthetics, etc.

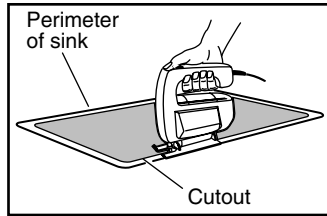

**3**

Mount the faucet and drain assembly on the sink or countertop following the manufacturer's instructions.

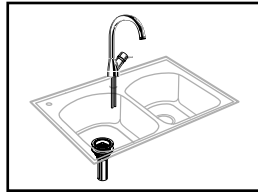

**4**

Before applying the sealant, place the sink temporarily into the cutout. Check for alignment and clearance, then trace around the outside edge of the sink as a guide for installation location and application of sealant.

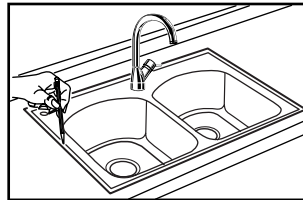

**5**

Remove sink and apply a masking tape outline 1/8" outside traced outline as a guide for application of silicone sealant.

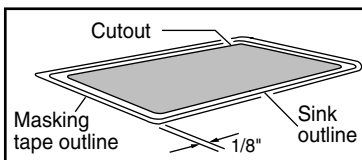

**6**

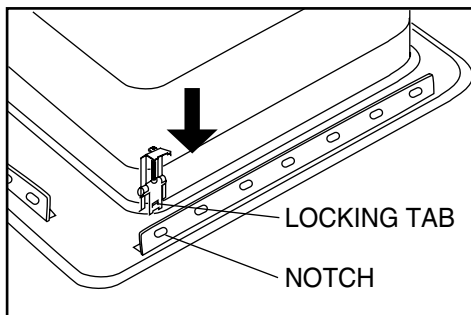

Place a retaining clip onto hold-down rib. Make certain locking tab engages depression in hold-down rib. Approximate locations shown on page 3 for correct model.

**7**

Rotate each retaining clip toward sink bowl.

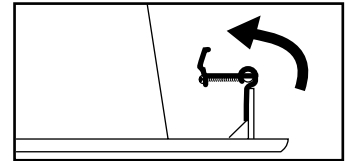

**8**

Apply a generous portion of sealant inside line traced on countertop. Carefully lower sink into cutout and press down firmly. Use guidelines for proper positioning.

**9**

Rotate each clip to engage countertop. **NOTE** - TIGHTEN THE TWO CENTER CLIPS ON EACH LONG SIDE OF THE SINK FIRST (SEE FIGURE 3 FOR DETAILS). Complete the tightening process for the remaining clips, to secure sink. Remove excess sealant from countertop for a smooth even line of sealant around the edge of the sink.

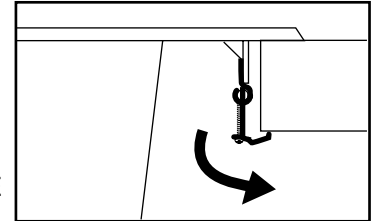

**10**

Connect supply lines to faucet finger tight, and carefully bend to engage with the supply stops. Tighten connections to faucet for secure seal.

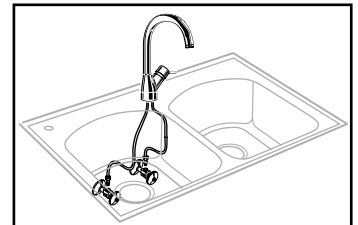

**11**

Connect drain assembly hand tight to check alignment. It may be necessary to cut off part of the tailpiece (area "A") or part of the horizontal leg of the trap (area "B").

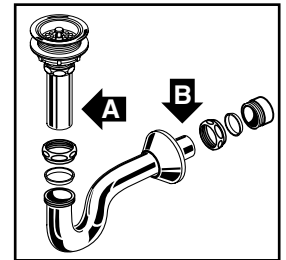

Secure joint for watertight assembly.

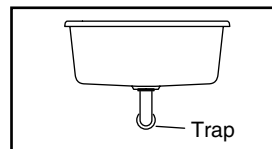

Single Bowl

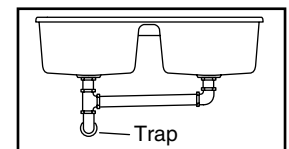

Double Bowl

**12**

Note: The clips supplied with sink can be used for a countertop with a thickness of 1/2" min. to 1" max. If countertop exceeds 1" thickness you must request clips for the larger thickness. Part No. 790772-0070A. If a plug is required to cover an unused hole, order Part No. 790773-0070A.

## Tightening Sequence For Clips

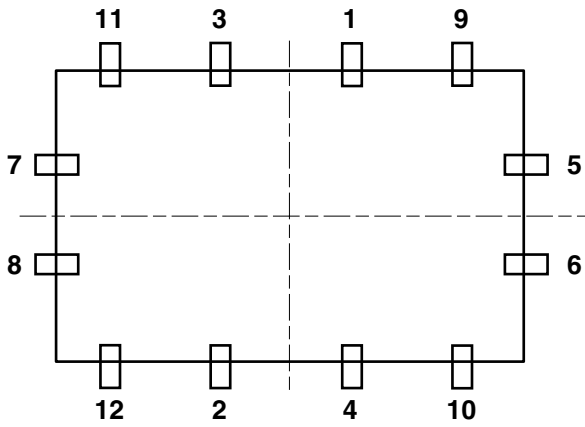

**MODEL 7501**

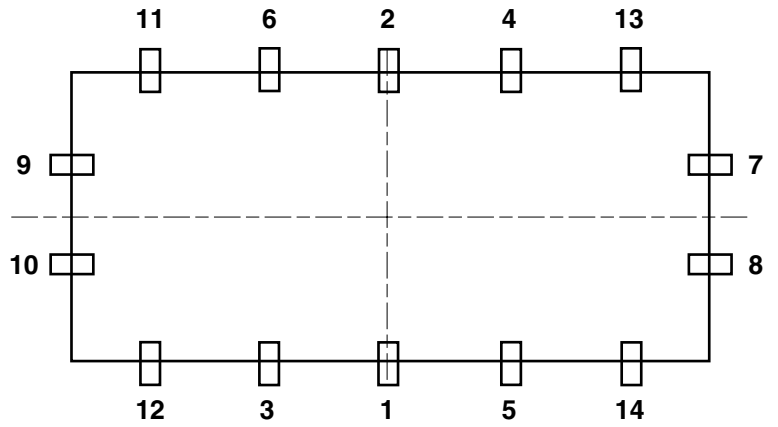

**MODEL 7502 & 7504**

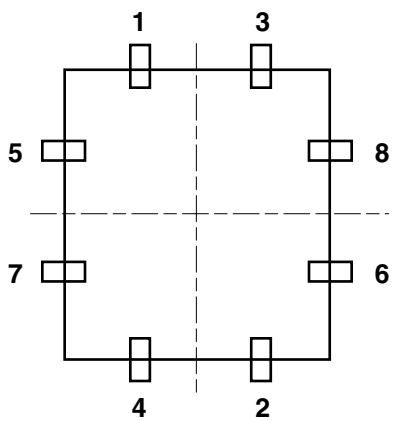

**MODEL 7507**

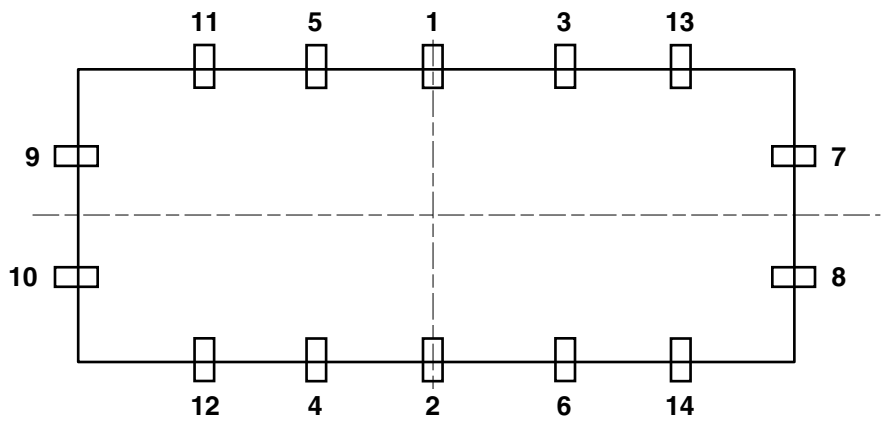

**MODEL 7510**

## Maintenance for stainless steel sinks:

To keep the original quality of your Stainless Steel Sink, we recommend regular cleaning. Use a mild liquid dish detergent and water to clean the product after use. Rinse carefully and dry.

## Please have the following in mind:

- Don't let water or other liquids dry on the product. Liquids that are left to dry leave a grey build-up stain on the steel.
- Stainless steel can stand hard treatment, but sharp objects can easily scratch the surface. These scratches are more visible when the product is new. After a period of use these marks will be smoothed out without the product losing its luster.
- Never use scouring powder or steel wool to clean the surface. Apart from the risk of scratches, there is also a risk that rust stains will attack the steel.
- Avoid Chlorine-based solutions from coming into contact with the stainless steel.
- Silver polish leaves spots that cannot be removed.
- Acidic foods (e.g. juices, salt, mustard, mayonnaise, etc.) must be cleaned up immediately.

## Discoloration

More stubborn spots are often caused by impurities in the water or household substances. These can be removed with special polish agents for stainless steel. Dull spots can become lustrous again if rubbed with chalk on a soft cloth.

### AMERICAN-STANDARD LIMITED LIFETIME WARRANTY FOR STAINLESS STEEL SINKS

American-Standard warrants to the original purchaser consumer of an American-Standard stainless steel sink that it will, at its option, repair or replace such product if it is found by American-Standard, in its sole judgment, to be defective under normal residential use, provided that it has been installed and maintained in accordance with American-Standard's instructions. This limited warranty applies only to the initial installation and is not transferable from the original consumer purchaser. In the event of a limited warranty claim, proof of purchase will be required – save sales receipt.

This limited lifetime warranty **DOES NOT COVER** the following:

1. Defects or damages arising from shipping, installation, alterations, accidents, abuse, misuse, environmental factors, lack of proper maintenance and use of other than genuine American Standard replacement parts, in all cases whether caused by a plumbing contractor, service company, the owner or any other person.
2. Deterioration through normal wear and tear and the expense of normal maintenance.
3. Commercial application.
4. Options and accessories. American-Standard's limited warranty on these items is one year for parts only. This one year limited warranty covers accessories manufactured by American-Standard against defects of material or workmanship. Limited warranty coverage begins on the date the accessory was originally purchased by the owner.
5. Postage or shipping costs for returning products for repairs or replacement under this limited warranty and labor or other costs incurred in connection with product removal or installation under this limited warranty.
6. ANY LIABILITY FOR CONSEQUENTIAL OR INCIDENTAL DAMAGES, INCLUDING LABOR, ALL OF WHICH ARE HEREBY EXPRESSLY DISCLAIMED, OR THE EXTENSION BEYOND THE DURATION OF THIS LIMITED WARRANTY OF ANY IMPLIED LIMITED WARRANTIES, INCLUDING THOSE OF MERCHANTABILITY OR FITNESS FOR AN INTENDED PURPOSE. IN NO EVENT WILL AMERICAN STANDARD BE LIABLE FOR THE COST OF REPAIR OR REPLACEMENT OF ANY INSTALLATION MATERIALS INCLUDING BUT NOT LIMITED TO TILES, MARBLE ETC. (Some jurisdictions do not allow limitations on how long an implied limited warranty lasts, or the exclusion or limitation of incidental or consequential damages, so these limitations and exclusions may not apply to you.)
7. Responsibility for compliance with local code requirements. (Since local code requirements vary greatly, distributors, retailers, dealers, installation contractors and users of plumbing products should determine whether there are any code restrictions on the installation or use of a specific product.)

This limited warranty gives you specific legal rights. You may have other legal rights that vary from state to state or from province to province.

#### In the United States:

American Standard Inc.,  
P.O. Box 6820  
Piscataway, New Jersey, 08855  
Attention: Director of Consumer Affairs

For residents of the United States, warranty information may also be obtained by calling the following toll free number: (800) 223-0068

#### In Canada:

American-Standard,  
2480 Stanfield Road  
Mississauga, Ontario  
Canada L4Y 1S2

Toronto Area: (905) 306-1093  
Toll Free: (800) 387-0369

#### In Mexico:

Ideal Standard, S.A. de C.V.  
Planta Santa Clara  
Via Morelos #330  
Santa Clara Coatitla  
Ecatepec de Morelos 55540,  
Estado de Mexico, Mexico

### UNDERCOUNTER MOUNTING FOR CULINAIRE™ COLLECTION STAINLESS STEEL KITCHEN SINKS

MODELS 7501.000, 7502.000, 7504.000, 7507.000

*Thank you for selecting American-Standard...the benchmark of fine quality for over 100 years.*

*To ensure that your installation proceeds smoothly-- please read these instructions carefully before you begin.*

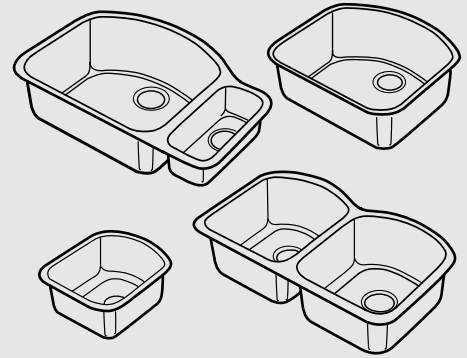

Certified to comply with ANSI A112.19.3.M  
CAN/C.S.A. B-45  
Observe local plumbing and building codes.

790766-100

#### BEFORE YOU BEGIN...

Unpack new sink and inspect carefully for damage. Notify your American Standard distributor of any damage. Replace the sink in its original packing carton to protect it until you are ready to begin installation.

#### Recommended Tools & Materials:

- |                      |                             |
|----------------------|-----------------------------|
| Putty Knife          | Basin Wrench                |
| Pipe Wrench          | Saber Saw                   |
| Channel Lock Pliers  | Plumbers' Putty or Caulking |
| Phillips Screwdriver | Tubing Cutter               |
| Regular Screwdriver  | Tape Measure                |
| Adjustable Wrench    | Hacksaw                     |
| Drill                | Mineral Spirits             |
|                      | Silicone Sealant            |

#### CAUTION

Minimum countertop thickness is 12mm (1/2") for marble and solid surface material.

#### SINK CUTOUTS:

- Locate and mark center lines of sink on countertop. Provide proper clearance under the countertop for the faucet supply lines and the structural parts of the cabinet. Do **not** use permanent markers to indicate the center lines.
- Cut the inner portion from the supplied template and discard.
- Attach the outer portion of the template to the countertop using masking tape. Be sure that the center lines on the template are aligned with those on the counter.
  - A. After cutout is complete, mark underside of countertop at approximate locations shown in 1 for appropriate model. Locate holes 1" back from cutout edge. Drill 1/4" diameter holes ('E' drill) 1/4" deep for brass inserts. Tap in brass inserts, slotted end first.
  - B. Some products are supplied with a plastic film. This film protects the product during the shipping and has to be removed before mounting. Apply sealant to mounting surface.
  - C. Mount hardware shown in Step 3 by first threading wingnut well up on screw near the head with washer and slotted clip. Tighten screw securely to lock brass insert.

When sink is correctly positioned over cutout, tighten wing nuts evenly to secure sink. (Refer to Step 3 on page 3.)

**IMPORTANT: DIMENSIONS OF FIXTURES ARE NOMINAL AND MAY VARY WITHIN THE RANGE OF TOLERANCES ESTABLISHED BY A.N.S.I. AND C.S.A. STANDARDS.**

**SUPPORT CLIP LOCATIONS:**

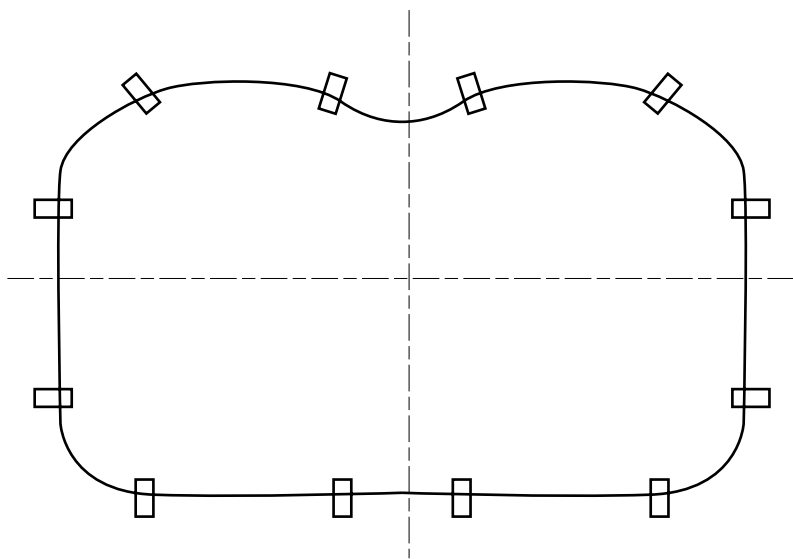

**MODEL 7502.000**

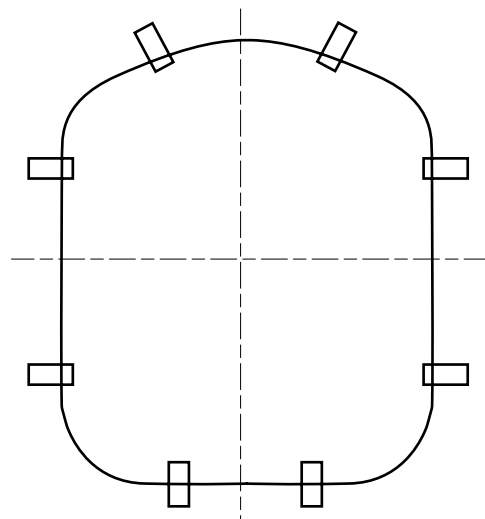

**MODEL 7507.000**

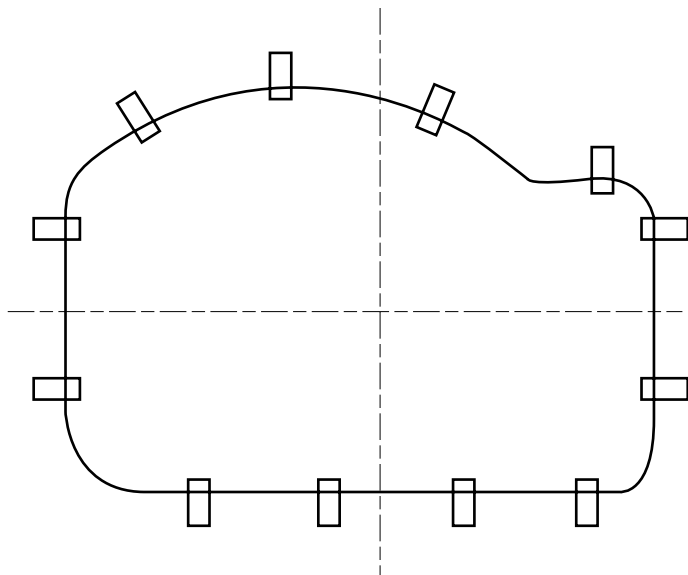

**MODEL 7504.000**

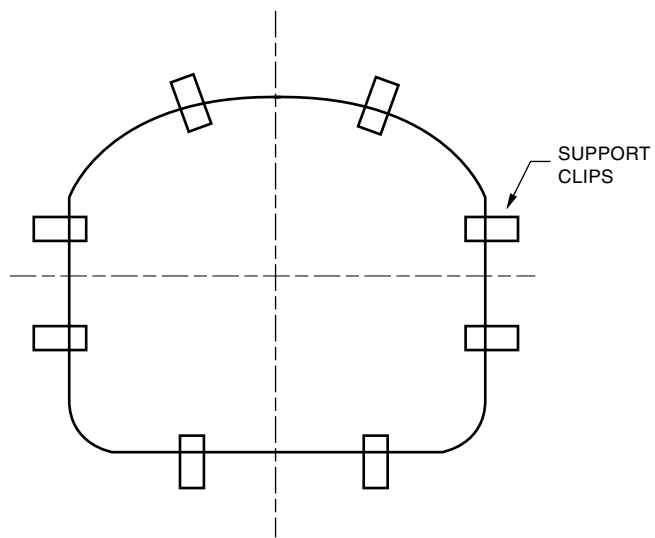

**MODEL 7501.000**

1

Drill a clearance hole inside the cutout line.

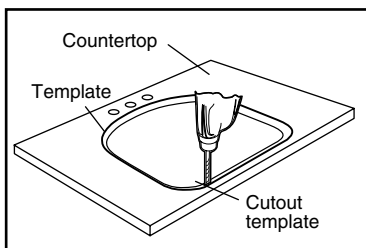

4

Mount the faucet and drain assembly following the manufacturer's instructions.

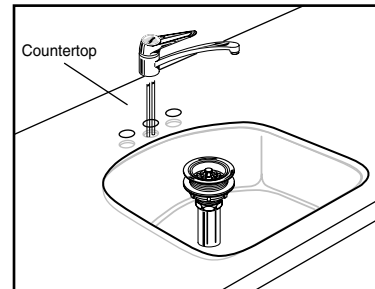

2

Cut opening on cut line of the template.  
**Note** - Contact your countertop distributor for the best method of cutting materials such as marble, hard synthetics, etc.

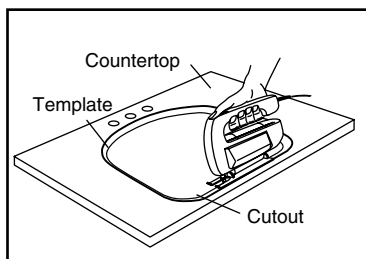

5

Connect supply lines to faucet finger tight, and carefully bend to engage with the supply stops. Tighten connections to faucet for secure seal.

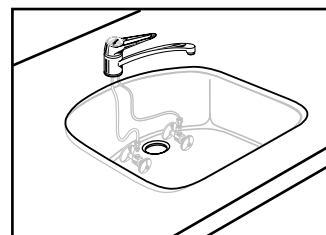

3

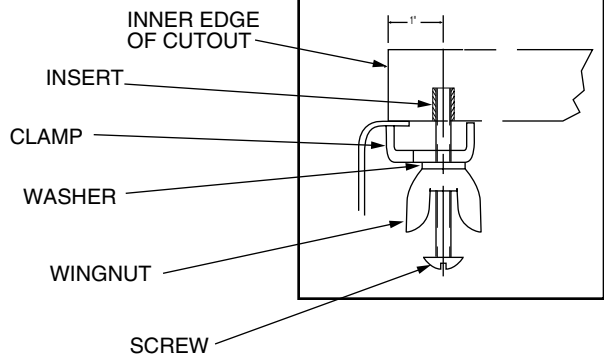

6

Connect drain assembly hand tight to check alignment. It may be necessary to cut off part of the tailpiece (area "A") or part of the horizontal leg of the trap (area "B").

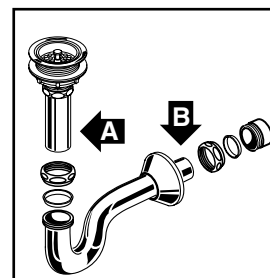

Secure joint for watertight assembly.

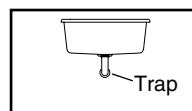

Single Bowl

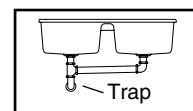

Double Bowl

END

## Maintenance for stainless steel sinks:

To keep the original quality of your Stainless Steel Sink, we recommend regular cleaning. Use a mild liquid dish detergent and water to clean the product after use. Rinse carefully and dry.

## Please have the following in mind:

- Do not let water or other liquids dry on the product. Liquids that are left to dry leave a grey build-up stain on the steel.
- Stainless steel can stand hard treatment, but sharp objects can easily scratch the surface. These scratches are more visible when the product is new. After a period of use these marks will be smoothed out without the product losing its luster.
- Never use scouring powder or steel wool to clean the surface. Apart from the risk of scratches, there is also a risk that rust stains will attack the steel.
- Avoid Chlorine-based solutions from coming into contact with the stainless steel.
- Silver polish leaves spots that cannot be removed.
- Acidic foods (e.g. juices, salt, mustard, mayonnaise, etc.) must be cleaned up immediately.

## Discoloration

More stubborn spots are often caused by impurities in the water or household substances. These can be removed with special polish agents for stainless steel. Dull spots can become lustrous again if rubbed with chalk on a soft cloth.

### AMERICAN-STANDARD LIMITED LIFETIME WARRANTY FOR STAINLESS STEEL SINKS

American-Standard warrants to the original purchaser consumer of an American-Standard stainless steel sink that it will, at its option, repair or replace such product if it is found by American-Standard, in its sole judgment, to be defective under normal residential use, provided that it has been installed and maintained in accordance with American-Standard's instructions. This limited warranty applies only to the initial installation and is not transferable from the original consumer purchaser. In the event of a limited warranty claim, proof of purchase will be required – save sales receipt.

This limited lifetime warranty **DOES NOT COVER** the following:

1. Defects or damages arising from shipping, installation, alterations, accidents, abuse, misuse, environmental factors, lack of proper maintenance and use of other than genuine American Standard replacement parts, in all cases whether caused by a plumbing contractor, service company, the owner or any other person.
2. Deterioration through normal wear and tear and the expense of normal maintenance.
3. Commercial application.
4. Options and accessories. American-Standard's limited warranty on these items is one year for parts only. This one year limited warranty covers accessories manufactured by American-Standard against defects of material or workmanship. Limited warranty coverage begins on the date the accessory was originally purchased by the owner.
5. Postage or shipping costs for returning products for repairs or replacement under this limited warranty and labor or other costs incurred in connection with product removal or installation under this limited warranty.
6. ANY LIABILITY FOR CONSEQUENTIAL OR INCIDENTAL DAMAGES, INCLUDING LABOR, ALL OF WHICH ARE HEREBY EXPRESSLY DISCLAIMED, OR THE EXTENSION BEYOND THE DURATION OF THIS LIMITED WARRANTY OF ANY IMPLIED LIMITED WARRANTIES, INCLUDING THOSE OF MERCHANTABILITY OR FITNESS FOR AN INTENDED PURPOSE. IN NO EVENT WILL AMERICAN STANDARD BE LIABLE FOR THE COST OF REPAIR OR REPLACEMENT OF ANY INSTALLATION MATERIALS INCLUDING BUT NOT LIMITED TO TILES, MARBLE ETC. (Some jurisdictions do not allow limitations on how long an implied limited warranty lasts, or the exclusion or limitation of incidental or consequential damages, so these limitations and exclusions may not apply to you.)
7. Responsibility for compliance with local code requirements. (Since local code requirements vary greatly distributors, retailers, dealers, installation contractors and users of plumbing products should determine whether there are any code restrictions on the installation or use of a specific product.)

This limited warranty gives you specific legal rights. You may have other legal rights that vary from state to state or from province to province.

#### In the United States:

American Standard Inc.,  
P.O. Box 6820  
Piscataway, New Jersey, 08855  
Attention: Director of Consumer Affairs

For residents of the United States,  
warranty information may also be  
obtained by calling the following  
toll free number: (800) 223-0068

#### In Canada:

American-Standard,  
2480 Stanfield Road  
Mississauga, Ontario  
Canada L4Y 1S2

Toronto Area: (905) 306-1093  
Toll Free: (800) 387-0369

#### In Mexico:

Ideal Standard, S.A. de C.V.  
Planta Santa Clara  
Via Morelos #330  
Santa Clara Coatitla  
Ecatepec de Morelos 55540,  
Estado de Mexico, Mexico