

INSTALLATION INSTRUCTIONS

Safe-T-Heater™ Whirlpool Heater

Models: 9075.120

*American
Standard*

Your Safe-T-Heater whirlpool bathtub heater has been specifically designed to enhance the enjoyment of your whirlpool bath. Once filled, the temperature of the whirlpool bath is constantly maintained by a built-in thermostat for as long as you desire.

Your Safe-T-Heater whirlpool bathtub heater is totally self contained to ensure trouble free installation and operation. As with all electrical devices, certain safety precautions should be taken during installation and operation. Please read and follow all instructions carefully.

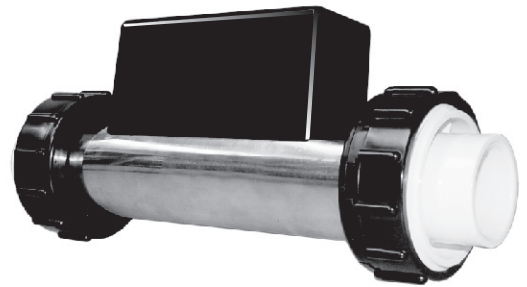

IMPORTANT SAFETY INSTRUCTIONS

INSTRUCTIONS PERTAINING TO A RISK OF FIRE, ELECTRIC SHOCK, OR INJURY TO PERSONS – READ AND FOLLOW ALL INSTRUCTIONS

You should have received safety instructions with your whirlpool bathtub system. Please read and follow them carefully. Those instructions will include the following warnings:

1. **WARNING – Risk of Electrical Shock –** Do not permit any electrical appliances (such as a light, telephone, radio, or television) within five feet of the whirlpool bathtub.
2. **DANGER –** To reduce the risk of injury, do not remove the suction cover from the whirlpool bathtub.
3. **To Reduce the Risk of Injury:**
 - a. The water in your whirlpool should not exceed 104° Fahrenheit. Lower water temperatures are recommended for extended use (exceeding 10-15 minutes) and are definitely recommended for younger children.
 - b. Pregnant or possibly pregnant women should consult a physician before using the whirlpool. Water temperatures in excess of 100° Fahrenheit are not recommended.
 - c. The use of alcohol, drugs or medication before or during the use of the whirlpool may lead to unconsciousness with the possibility of drowning. Consult your physician before using the whirlpool if you are using any medication.
 - d. Persons suffering from obesity or with a medical history of heart disease, low or high blood pressure, circulatory system problems or diabetes should consult a physician before using the whirlpool.
4. **WARNING – Risk of Child Drowning –** To reduce the risk of accidental drowning, do not permit children to use the whirlpool unless they are closely supervised.
5. **WARNING – RISK OF ELECTRICAL SHOCK –** All electrical connections must be accomplished by a qualified electrician in accordance with Article 680 of the National Electric Code and any local codes. In addition, a GFCI **MUST** protect all branch circuits to the whirlpool, and every electrical component **MUST** be grounded.
6. The unit must be connected only to a supply circuit that is protected by a ground-fault circuit-interrupter (GFCI). Such as GFCI should be provided by the installer and should be tested on a routine basis. To test the GFCI, push the test button. The GFCI should interrupt power. Push the reset button. Power should be restored. If the GFCI fails to operate in this manner, the GFCI is defective. If the GFCI interrupts power to the bathtub without the test button being pushed, a ground current is flowing, indicating the possibility of an electric shock. Do not use this bathtub. Disconnect the hydromassage bathtub and have the problem corrected by a qualified service representative before using.
7. **WARNING – Prolonged immersion in hotter water may induce hyperthermia.** Hyperthermia occurs when the internal temperature of the body reaches a level several degrees above the normal body temperature of 98.6°F. The symptoms of hyperthermia include an increase in the internal temperature of the body, dizziness, lethargy, drowsiness, and fainting. The effect of hyperthermia include:
 - a. Failure to perceive heat
 - b. Failure to recognize the need to exit the bathtub
 - c. Unawareness of impending hazard
 - d. Fetal damage in pregnant women
 - e. Physical inability to exit the bathtub

SAVE THESE INSTRUCTIONS

OPERATION

WARNING: Prior to operation, review the Important Safety Instructions listed at the beginning of this instruction manual.

Once the heater is installed and the whirlpool pump is operating, the heater is totally automatic. The heater will help maintain the temperature of the water in the bath.

Pressure Switch

The heater is equipped with a preset pressure switch. The pump must be running with water flowing in the whirlpool to allow the heater to turn on.

Indicator Light

This light turns on whenever the heater is operating (Fig. 1).

High-Limit Switch

To manually reset the circuit in the event that the “High-Limit” switch has been activated, simply (1) Turn off the whirlpool pump (2) Drain water from the tub (3) Remove power from heater by unplugging at receptacle or turning off circuit breaker (4) The heater circuit will automatically reset in less than 15 minutes (5) Restore power to the heater (6) Whirlpool bath is now ready to use.

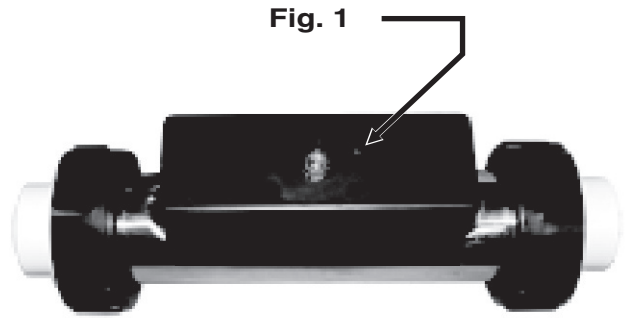

ELECTRICAL CONNECTIONS

Install a separate 120VAC / 15AMP dedicated circuit with GFCI (Ground Fault Circuit Interrupter) protection.

At initial start-up with power ON, push the GFCI test button. The reset button should pop out. Push this button in to reset. If the GFCI fails to operate in this manner, there is a ground fault or malfunction, indicating the possibility of electrical shock. **Turn off the power and do not use the bath until the source of the problem has been identified and corrected.**

1. Route two separate branch circuits to the junction box near the whirlpool as shown in Figure 2. Each branch circuit **MUST BE GFCI PROTECTED** and must use copper conductors only.
2. Ensure the heater and pump are properly **GROUND**ED and **BONDED** as required. Attach the 8 AWG solid copper conductor supplied with the heater from the heater bonding lug to the motor frame bonding lug as shown in Figure 3. The conductor is secured to the lugs using set screws. The motor frame shall have a second 8 AWG solid copper conductor connected from the frame bonding lug to the homes electrical panel or approved local bonding point as shown in Figure 3.

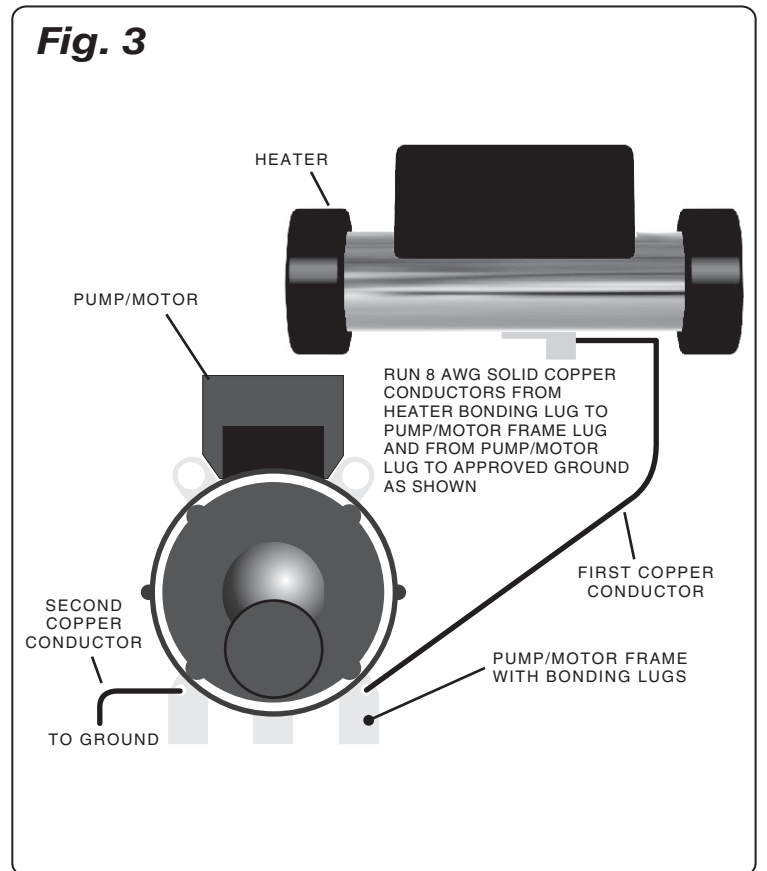
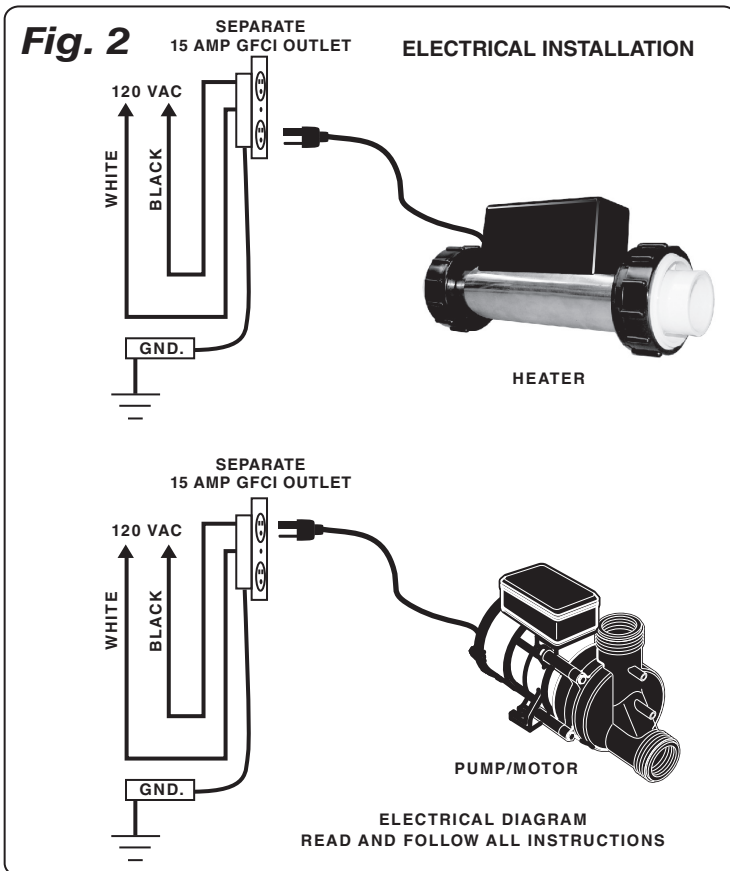

INSTALLATION INSTRUCTIONS

To insure that you have received the proper heater designed to operate specifically with your bathtub, locate the bathtub part number within the approved list located on the heater assembly. If you cannot locate the specific bathtub part number, do not install the heater assembly until the proper heater is received.

1. The Safe-T-Heater can be installed either before or after bathtub installation.

2. Identify the location of the inline heater blank. It should be near the pump as shown in photo #1.

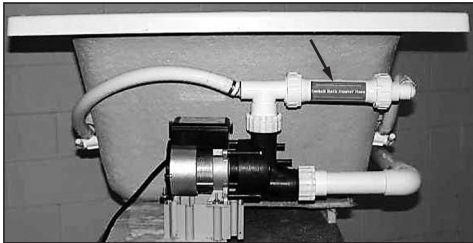

Photo 1

3. Using channel lock pliers, loosen the couplings from the whirlpool piping (photo # 2).

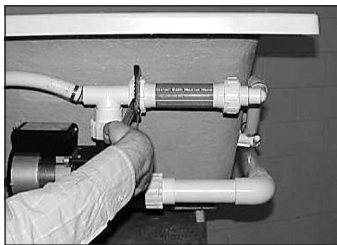

Photo 2

4. Remove the spacer pipe leaving the gaskets on the whirlpool pipe connections (photo #3).

NOTE - Gaskets must be in place to insure a watertight seal.

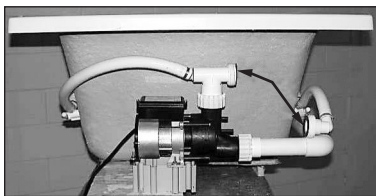

Photo 3

5. Insert the Safe-T-Heater in the open space on the piping and connect the couplings on the heater to the whirlpool piping (photo # 4).

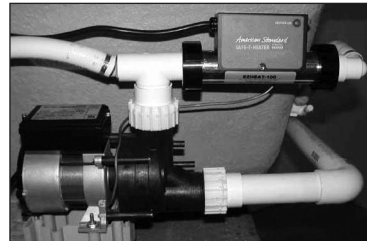

Photo 4

6. Tighten the couplings with the channel lock pliers (photo #5).



Photo 5

7. Fill the tub with water and check for leaks.

8. Install heater ground per Figure 3 and plug the Safe-T-Heater power cord into the dedicated 15 amp GFCI outlet.

9. Start the pump and confirm that there are no leaks.

10. Turn the pump on and look to see if the light on the Safe-T-Heater is lit. This indicates that the heater is operating. If not, check the electrical connections at the outlet.

AS AMERICA, INC. (AMERICAN STANDARD) ONE YEAR LIMITED WARRANTY FOR SAFE-T-HEATER™ WHIRLPOOL HEATER

If inspection of this AS American, Inc. ("American Standard") plumbing product, within one year after its initial purchase, confirms that it is defective in materials or workmanship, American Standard will repair or, at its option, exchange the product for a similar model.

This warranty applies only to the original purchaser and installation of these products.

This limited warranty **does not apply** to local building code compliance. Since local building codes vary considerably, the purchaser of this product should check with a local building or plumbing contractor to insure local code compliance before installation.

This warranty **shall be void** if the product has been moved from its initial place of installation; if it has been subjected to faulty maintenance, abuse, misuse, accident or other damages; if it was not installed in accordance with American Standard's instructions; or if it has been modified in a manner inconsistent with the product as shipped by American Standard.

American Standard's option to repair or exchange the product under this warranty does not cover any labor or other costs of removal or installation, **nor shall American Standard be responsible for any other incidental or consequential damages attributable to a product defect or to the repair or exchange of a defective product, all of which are expressly excluded from this warranty.** (Some states or provinces do not allow the exclusion or limitation of implied warranties, so this exclusion may not apply to you.)

This warranty gives you specific legal rights. You may have other statutory rights that vary from state to state or from province to province, in which case this warranty does not affect such statutory rights.

For service under these warranties, it is suggested that a claim be made through the contractor or dealer from or through whom the product was purchased, or that a service request (including a description of the product model and of the defect) be sent to:

By Mail:

American Standard Brands
1 Centennial Ave.
Piscataway, New Jersey 08854
Attention: Director of Customer Care

For residents of the United States, warranty information may also be obtained by calling the following toll free number: (800) 442-1902
www.americanstandard.com