

F202ALT-2

TECHNICAL DATA SHEET

quarto 4-hole deck mount tub
filler, open extended spout

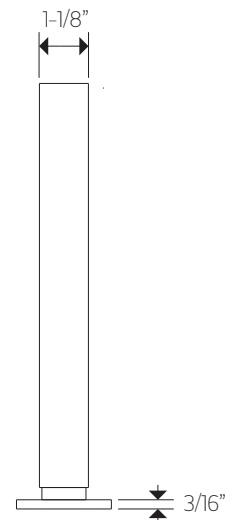
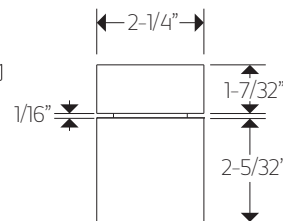
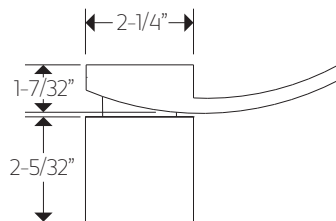
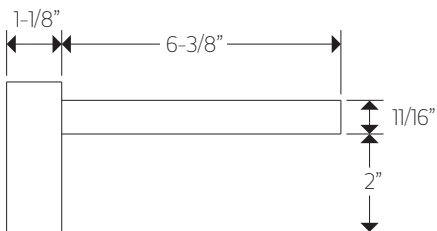
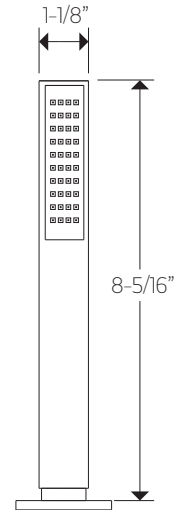
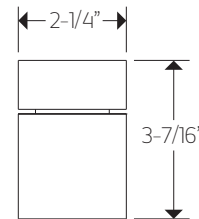
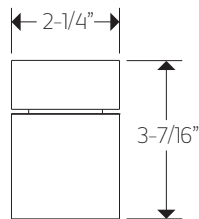
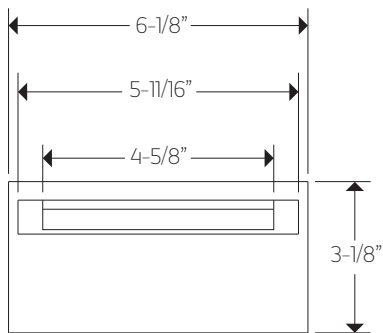

artos

F202ALT-2

OPERATING SPECIFICATIONS

quarto 4-hole deck mount tub
filler, open extended spout

FEATURES

Waterfall Flow

Hand Shower with Separate Control

OPERATING PRESSURE

Minimum: 15 psi

Maximum: 75 psi

Above 90psi it may be necessary to install a pressure
reducer

OPERATING TEMPERATURE

Maximum: 176°

FLOW RATE

6.0 USGPM

2.0 USGPM

