

Installation Guide

SHOWER RAIN HEAD CEILING MOUNT

F703-2/5

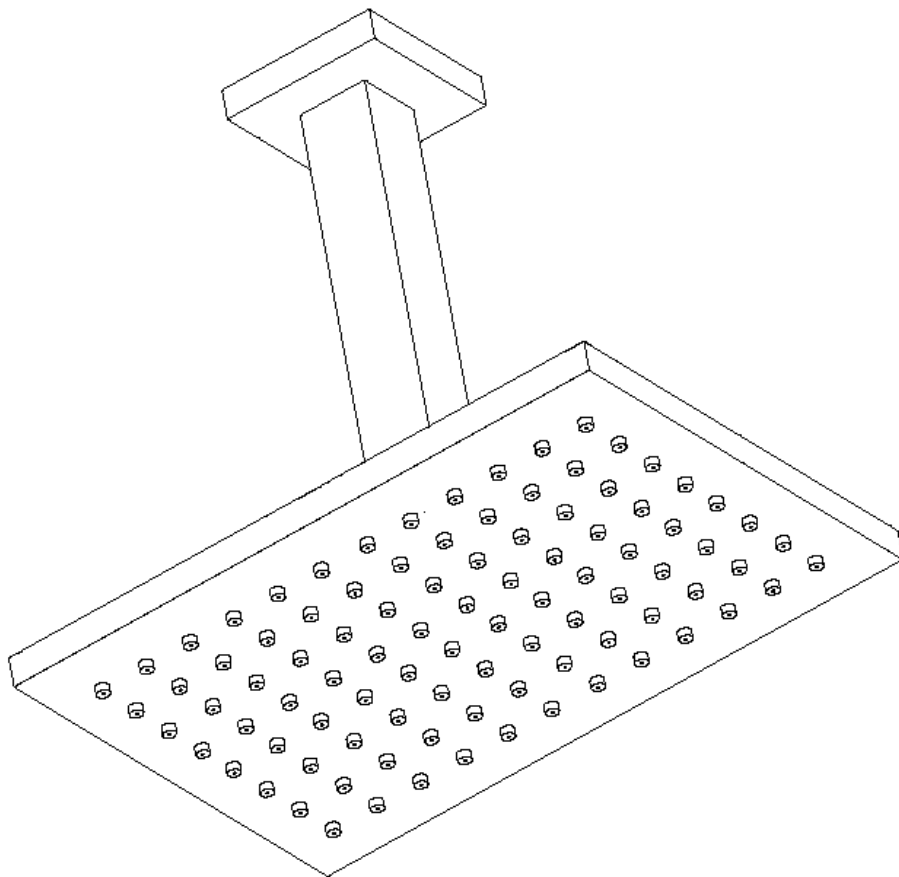

703250411

This publication is for illustrative purposes only and we reserve the right to change details at anytime as deemed necessary.

(fig A)

DIMENSIONS

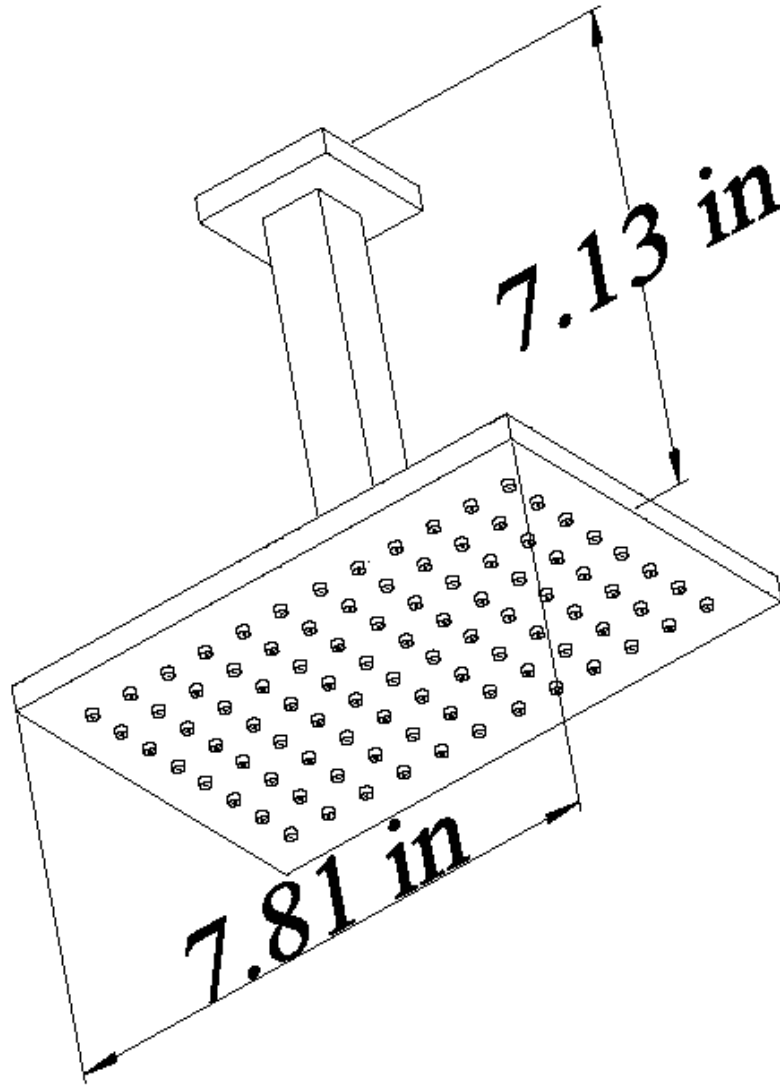

SPECIFICATIONS

Recommended flow pressure between 15 and 75 psi. Above 90 psi it may be necessary to install a pressure reducer. Maximum operating temperature 176°F

703250411

INSTALLATION STEPS

1. Prepare rough in connection in the wall to accept threaded arm so that rear of escutcheon is against finished wall surface.
2. If rough in is prepared before wall finish thickness is known, set outlet at least 2.5 " behind the cement board and use connector and nipple to achieve correct positioning.
3. Thread arm into wall outlet.
4. Thread the head on to the arm.
5. Turn on water supply and check for water tightness.

CARE & MAINTENANCE

For best results, keep the following in mind to retain the high quality finish of your *ARTOS* faucet:

- Use a soft, dampened sponge or cloth. On no account should you use an abrasive material such as a brush, scouring pad or steel wool to clean surfaces.
- Test your cleaning agent solution on an inconspicuous area before applying to the entire faucet.
- Wipe surfaces clean and rinse completely with water immediately after applying cleaning agent.
- An ideal cleaning technique is to rinse faucet thoroughly and blot dry any water from the surface after each use.

LIMITED LIFETIME WARRANTY

Artos® Limited Lifetime Warranty

Artos® faucets have been manufactured under the highest quality and manufacturing standards. Artos® faucets are guaranteed for life against leaks and manufacturing defects for as long as the original consumer purchaser owns it. This warranty applies to installations in the US, Canada and Mexico (North America). Commercial, Industrial or business uses are warranted for a period of one year from the original date of purchase.

This warranty is non-transferable and applies exclusively to the original owner or end-user. If a defect is found during normal use, Artos® will, at its election, repair, replace or make an appropriate adjustment. Damage caused by accident, misuse, abuse, improper installation or alteration will void the warranty. This warranty does not cover replacement parts where damage is caused by normal wear and tear. Labor charges, installation or other incidental or consequential costs will not be covered.

Replacement parts that qualify for warranty repair can be obtained by contacting Artos® at 1-877-9ARTOS9 or by e-mail at info@artos.us.com. Proof of purchase (original sales receipt) from the original consumer purchaser must accompany all warranty claims. When submitting your claim in writing, please provide your name, address and telephone number.

Please register this product online at WWW.ARTOS.US.COM

Item No : **F 703-2-5**
Serial No :

703250411