

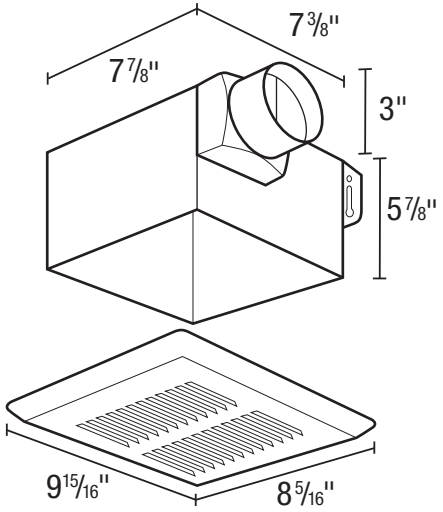

SPECIFICATIONS
FRAS50
 EXHAUST FAN

50 CFM/3.0 Sones @ 0.10" SP.



- **Grill**
Cold rolled steel, powder coated white.
 - **Blower Wheel**
One piece polymeric wheel, 4 1/2" diameter, 1" wide, with 10 fins.
 - **Motor**
Single coil plug-in, two pole motor, life time lubrication, thermally protected. Rated 120 volts, 60 hz.
Contractor Pack (Motor/BladeGrill) Model: FA50T*
 - **Fan Housing**
24 gauge galvanized steel housing, dimensions 7 3/8" x 7 5/8" x 5 7/8".
Contractor Pack Model: AKFH1*
 - **Duct Collar**
Metal collar for 3" duct connection, comes complete with built in back draft damper.
 - **Damper**
Blanket - Non-asbestos, ceramic blanket
Fusible Link - Replaceable, 165°F standard
Classification - CUL Listed 555C and 263. California State Marshall classification for 3 hour fire damper rating. California State Marshall listing number 3226-1721:0109.
Contractor Pack Model: AKFD1*
 - **Unit Mounting**
FRAS50 is centered between joists (with 16" centers) using hanging brackets. The housing will mount through drywall thickness up to 3/4", with a rough-in opening of 7 3/8" x 7 5/8".
- * Sold in packs of 4. All three parts (housing, damper, motor/blade/grill) must be purchased and used together to make a complete unit.

Acceptable for use over tub or shower when installed in a GFCI protected branch circuit.

- **Ventilating Area**
For rooms up to 60 sq. ft.
- **Wood Frame Truss Design Listings**
ETL Classified UL263/E119:
L501, L502, L503, L506, L507, L508, L512, L513, L514, L515, L516, L517, L519, L521, L522, L523, L528, L530, L533, L537, L545, L546, L550, L562, L563, L570, L574, L579, L581, L583, L585, L586, M503, M530, M538, P522, P531, P538, P545, P552
- cULus:** L501, L502, L503, L506, L507, L508, L512, L513, L514, L515, L516, L517, L519, L522, L523, L533, L537, L545, L581, L583, M530, M538

EXPANDED PERFORMANCE											
	Static Pressure (inches of w.g.)							Sones @ .1 SP	Fan Speed RPM	Power Watts	Amps
	0	0.05	0.1	0.125	0.15	0.2	0.25				
Air Flow - CFM	55	53	50	49	47	44	39	3.0	2125	48.0	0.9

PROJECT							ARCHITECT				
LOCATION							ENGINEER				
CONTRACTOR							SUBMITTED BY			DATE	
FAN NUMBER	MODEL NUMBER	CFM	IN W.G.	RPM	WATTS	AMPS	SONES	QTY	OPTIONAL EQUIPMENT & REMARKS		



U.S.: 820 Lincoln Avenue
 West Chester, Pennsylvania 19380-4466
 Tel: (610) 692-7400 • 877-304-3785
 Fax: (610) 696-8048

Canada:
 Brampton, Ontario
 Tel: 905-456-2033
 Fax: (905) 456-1015