

Model No :: **62557LEDD-MSS/CCLCLR**
 Name :: Private Collection



Project Name :: _____
 Location :: _____
 Type :: _____
 Quantity :: _____
 Notes :: _____

Product Information

Product ID :: 62557
 UPC Code :: 641594223804
 Mounting Type :: Wall
 Finish :: Mirrored Stainless Steel (MSS)
 Diffuser :: Clear Crystal with Clear Glass (CCLCLR)
 Alt. Finishes :: Mirrored Stainless Steel (MSS)
 Alt. Diffusers :: Clear Crystal with Clear Glass (CCLCLR)

Product Dimensions

Fixture		Canopy	
Length ::	N/A	Length ::	N/A
Width ::	28.5"	Width ::	N/A
Diameter ::	N/A	Diameter ::	N/A
Extension ::	5.75"	Height ::	N/A
Height ::	4.75"		
Overall Height ::	N/A		



Technical Specifications

Qualifications	Specifications	Photometrics	Recommended Dimmers
Location Rating :: Damp	Frame Material :: Stainless Steel	CCT :: 3000	(ELV) LUTRON Caseta PD - 6WCL; (ELV) LUTRON Maestro CL MACL-153M; (ELV) LUTRON Skylark Contour CTCL-153P; (TRIAC) LEVITON Decora Sureslide 6674; (TRIAC) LUTRON Diva DVCL-153P
Certification :: ETL Listed (US/Canada)	Diffuser Material :: Glass	CRI :: 80	
IES File ::	Voltage :: 120v	Wattage :: 20w	
JA8 Compliant :: No	Lamping Type :: Dedicated LED	Nominal Lumens :: 1800Lm	
Energy Star :: No	Lamping Base :: SSL	Delivered Lumens :: N/A	
ADA Compliant :: No	Lamp Quantity :: 4	Additional Items :: 0	
Marine Grade :: No	Lamp Wattage :: 5 W		
Emergency Lighting :: No	Total Wattage :: 20w		
Warranty :: 5 Year Limited	Lamps Included :: Yes		
	J-Box Type :: Standard		

Line Drawing #1



Line Drawing #2

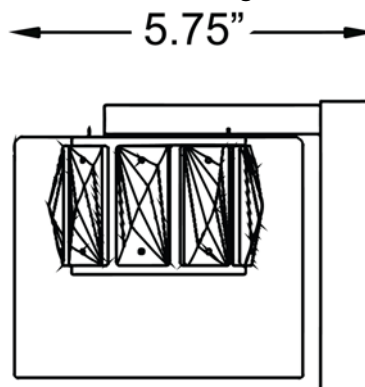

IES File

Image Not Available

Toll Free 800-828-5483 • www.AccessLighting.com

14410 Myford Road, Irvine, CA 92606

The information provided is subject to change without notice. ©2020 Access Lighting Corporation. All Rights Reserved
 Rev. 202004 Filename:: 62557LEDD-MSS_CCLCLR.pdf

