

# access

L I G H T I N G

## INSTALLATION INSTRUCTIONS

### IMPORTANT

Before assembling your ACCESS LIGHTING fixture, please make sure that you carefully read through these instruction sheets. Consider having your fixture installed by a qualified licensed electrician.

**NOTE:** The important safeguards and instructions that appear in this manual are not meant to cover all possible conditions and situations that may occur. It must be understood that common sense, caution and care, are factors that can't be built into any product. These factors must be supplied by the person(s) caring for and operating the fixture.

### GENERAL INFORMATION

All electrical connections must be in accordance with all ordinances, Local and National Electrical Codes. These fixtures are intended for mounting to a standard 4" x 2 1/2" metal octagon outlet box. The box must be directly supported by the building structure and U.L. Recognized.

### STEP BY STEP INSTRUCTIONS

Before starting your installation disconnect the Power by turning off the Circuit Breaker or by removing the fuse at the fuse box. Just turning the light off at the light switch is not sufficient to prevent electrical shock.

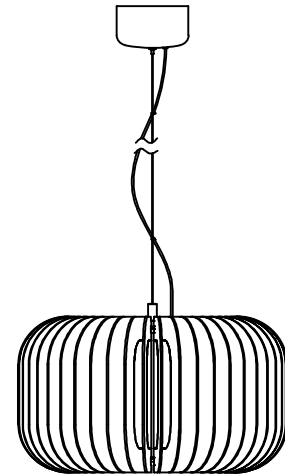

**COLLECTION**  
DIMENSIONS

**APPLICATION**  
Pendant

**MODEL NO.**  
62331LEDD

### WHAT WE PROVIDE

- Crossbar
- Mounting Hardware
- 46 x Acrylic diffusers
- LED

### WHAT YOU NEED

- Screwdriver
- Wire Cutters
- Wiring Supplies as Specified by Electrical Code

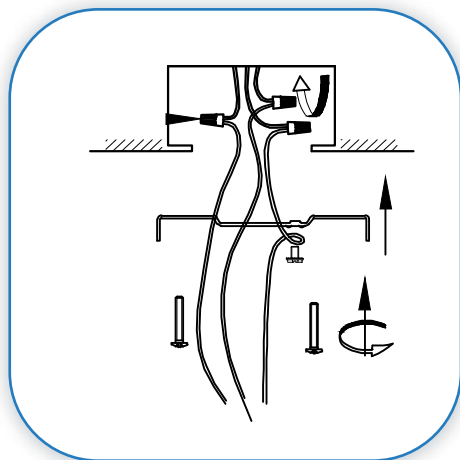

# 1

### PREPARE FIXTURE AND MOUNT THE CROSSBAR

If there is an existing fixture remove it.

Expose the supply wire from the outlet box. Mount the crossbar to the junction box with the supplied screws.

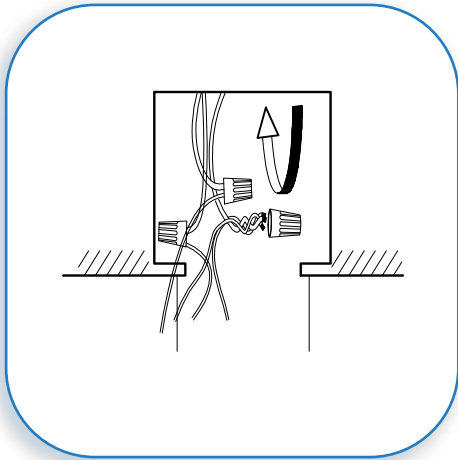

2

### MAKE WIRE CONNECTIONS

Gently pull the supply wires through the hole in the crossbar. Connect the black supply wire to the black fixture wire. Secure with the supplied wire nuts. Connect the white supply wires to the white fixture wire. Secure with the supplied wire nuts. Either wrap the green wire around one of the protruding screws or connect it to the supply ground wire. Secure all wire with electrical tape (not supplied). Tuck all wires carefully into the J-Box.

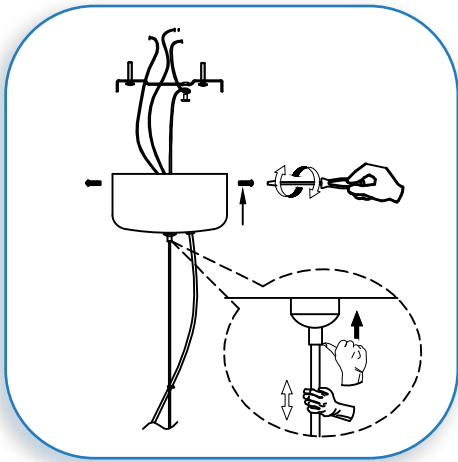

3

### MOUNT FIXTURE TO THE CROSSBAR PLATE

Adjust the length of fixture by using grip lock. Position the canopy over the crossbar plate. Align the holes in the side of the canopy and secure with the supplied screws.

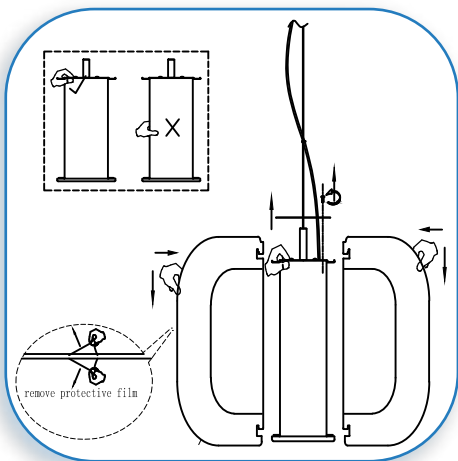

4

### INSTALL THE ACRYLIC DIFFUSERS

Put up the metal ring from the top of LED cylinder. Installed the acrylic diffusers one by one. Please wear clean gloves when installing acrylic diffusers. Organic solvent should be prohibited from the acrylic diffusers and only use cotton fabric wetting with water when clean it.

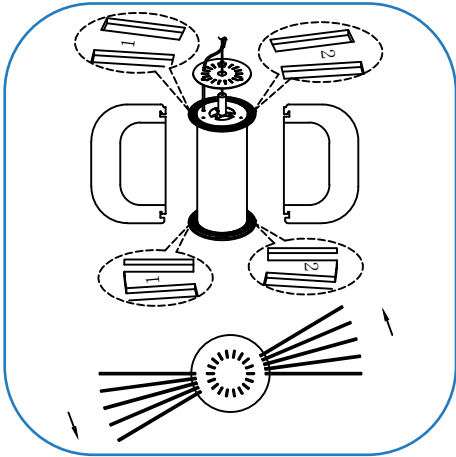

5

**INSTALL THE ACRYLIC DIFFUSERS**

Install the diffusers one from right and one from left in order to balance the fixture.

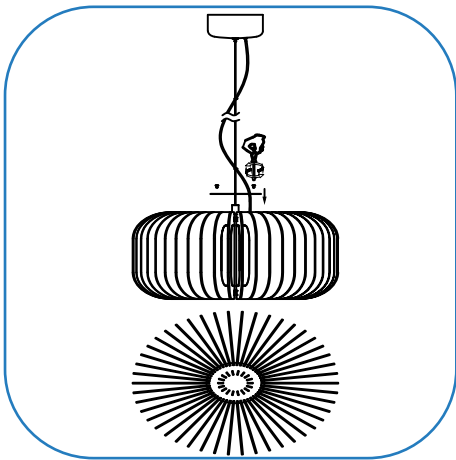

6

**SECURE THE ACRYLIC DIFFUSERS**

Put down the metal ring from the top LED cylinder and secure with the supplied screws.

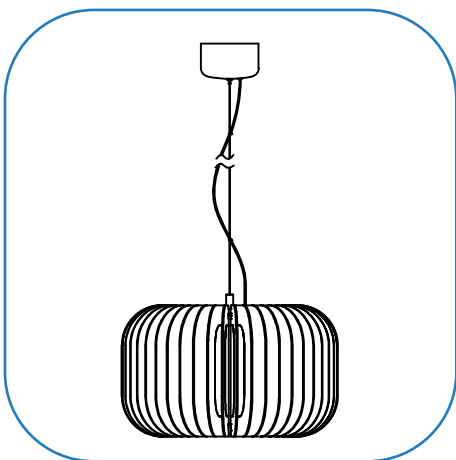

7

**RESTORE THE ELECTRICITY AND CHECK THE OPERATION OF YOUR NEW ACCESS LIGHTING FIXTURE**

**CAUTION** If the fixture is to be removed or replaced, please ensure that the electricity is switched off and that the fitting is cool before touching it.