

access

L I G H T I N G

INSTALLATION INSTRUCTIONS

IMPORTANT

Before assembling your access lighting fixture, please make sure that you carefully read through these instruction sheets. Consider having your fixture installed by a qualified licensed electrician.

NOTE: The important safeguards and instructions that appear in this manual are not meant to cover all possible conditions and situations that may occur. It must be understood that common sense, caution and care, are factors that can't be built into any product. These factors must be supplied by the person(s) caring for and operating the fixture.

GENERAL INFORMATION

All electrical connections must be in accordance with all ordinances, Local and National Electrical Codes. These fixtures are intended for mounting to a standard 4" x 2 1/2" metal octagon outlet box. The box must be directly supported by the building structure and U.L. Recognized.

STEP BY STEP INSTRUCTIONS

Before starting your installation disconnect the Power by turning off the Circuit Breaker or by removing the fuse at the fuse box. Just turning the light off at the light switch is not sufficient to prevent electrical shock.

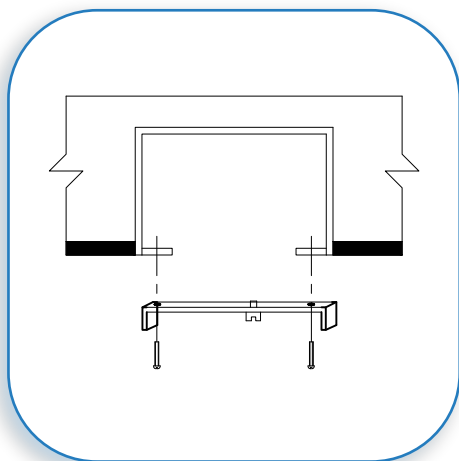

COLLECTION
Milano

APPLICATION
Pendant

MODEL NO.
55533

WHAT WE PROVIDE

- Crossbar
- Mounting Hardware
- Canopy with Fixture
- 6 x Glass Shades
- 3 x Rods
- 6 x 60W G9 Bulbs

WHAT YOU NEED

- Screwdriver
- Wire Cutters
- Wiring Supplies as Specified by Electrical Code

PREPARE FIXTURE

1

If there is an existing fixture remove it.

Expose the supply wire from the outlet box .

Determine the desired length of your fixture.

Feed the wires through the rods based upon the desired length. Screw the bottom rod to the socket plate and follow suit with additional rods.

Feed the wire through the hole in the canopy and secure the top rod to the canopy.

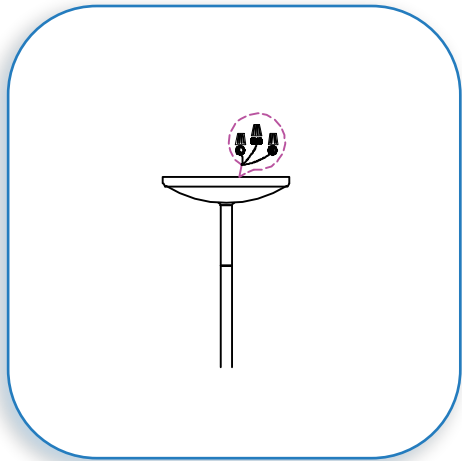

2

CONNECT THE WIRES

Mount the crossbar to the J-Box such that the U-shaped arms face downward.

Gently pull the supply wires. Connect the black supply wire to the black fixture wire. Secure with the supplied wire nuts. Connect the white supply wires to the white fixture wire. Secure with the supplied wire nuts. Either wrap the green wire around one of the protruding screws or connect it to the supply ground wire. Secure all wires with U.L. Certified electrical tape (not supplied).

Tuck all wires carefully into the J-Box.

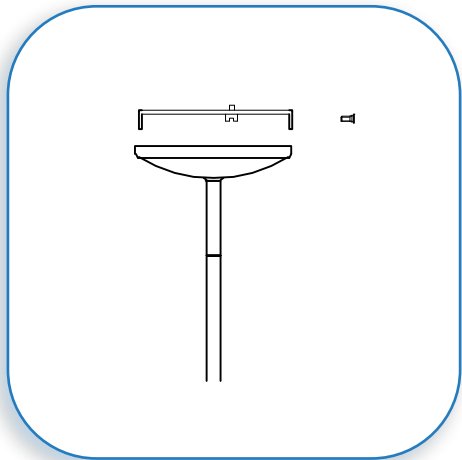

3

MOUNT THE CANOPY

Hold the fixture canopy up to the crossbar. Align the holes in the U-shaped arms of the crossbar with the holes on the sides of the canopy. Secure with the supplied screws.

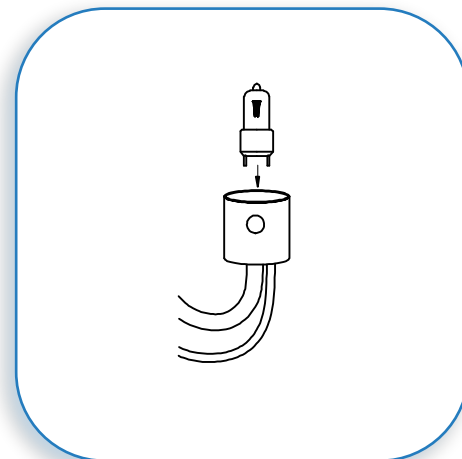

4

INSERT THE BULBS

Insert the bulbs .

MAXIMUM WATTAGE 60W.

DO NOT EXCEED THE RECOMMENDED WATTAGE AS STATED ON THE WARNING LABEL AND INSTRUCTION SHEETS.

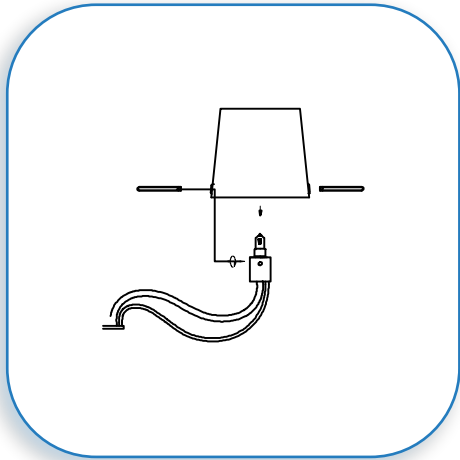

5

SECURE GLASS SHADES

Place the glass shades over the socket and secure by screwing the glass retaining pins into the designated holes in the socket.

6

RESTORE THE ELECTRICITY AND CHECK THE OPERATION OF YOUR NEW ACCESS FIXTURE

CAUTION

Please ensure that the fitting is cool and switched off before replacing the bulb. DO NOT use bulbs that might exceed the maximum wattage, stated on caution label.