



INSTALLATION INSTRUCTIONS

IMPORTANT

Before assembling your access lighting fixture, please make sure that you carefully read through these instruction sheets. Consider having your fixture installed by a qualified licensed electrician.

NOTE: The important safeguards and instructions that appear in this manual are not meant to cover all possible conditions and situations that may occur. It must be understood that common sense, caution and care, are factors that can't be built into any product. These factors must be supplied by the person(s) caring for and operating the fixture.

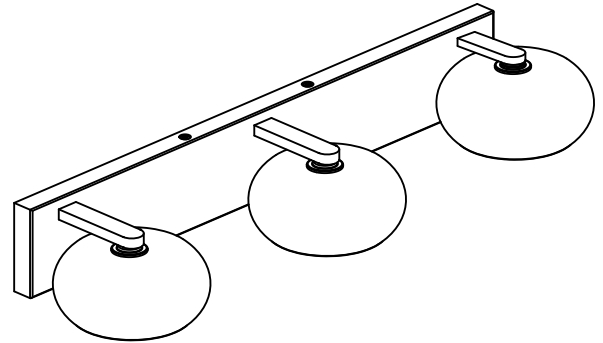

GENERAL INFORMATION

All electrical connections must be in accordance with all ordinances, Local and National Electrical Codes. These fixtures are intended for mounting to a standard 4" x 2 1/2" metal octagon outlet box. The box must be directly supported by the building structure and U.L. Recognized.

STEP BY STEP INSTRUCTIONS

Before starting your installation disconnect the Power by turning off the Circuit Breaker or by removing the fuse at the fuse box. Just turning the light off at the light switch is not sufficient to prevent electrical shock.

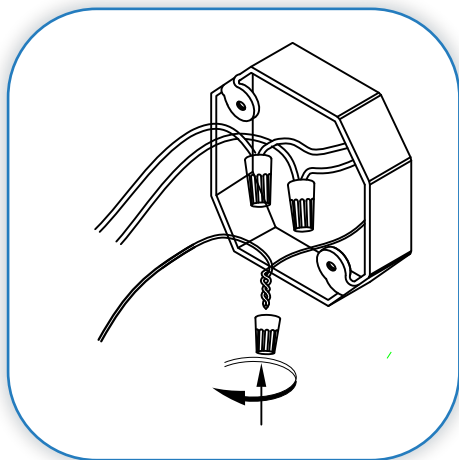

COLLECTION
GLAM

APPLICATION
Wall Fixture

MODEL NO.
52113

WHAT WE PROVIDE

- Mounting Hardware
- Crossbar Plate
- 3 x Glass and crystal beads shade
- 3 x 48W Xenon G9 Bulbs

For energy saving, this fixture is supplied with

48W G9/ER bulbs, which is equivalent to

60W standard G9 Halogen.

WHAT YOU NEED

- Screwdriver
- Wire Cutters
- Wiring Supplies as Specified by Electrical Code

PREPARE FIXTURE

1

If there is an existing fixture remove it.
Expose the supply wire from the outlet box.

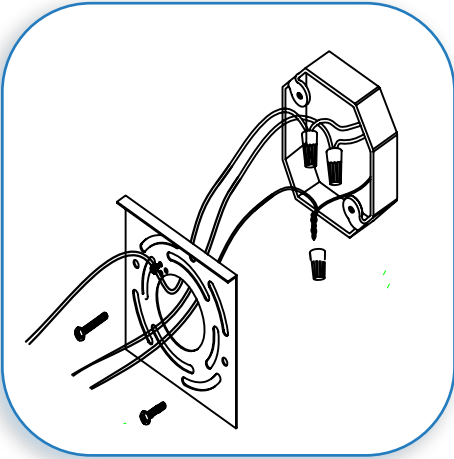

2

MOUNT CROSSBAR PLATE

Gently pull the supply wires out of the j-box.
Mount the crossbar to the J-box with the supplied screws.

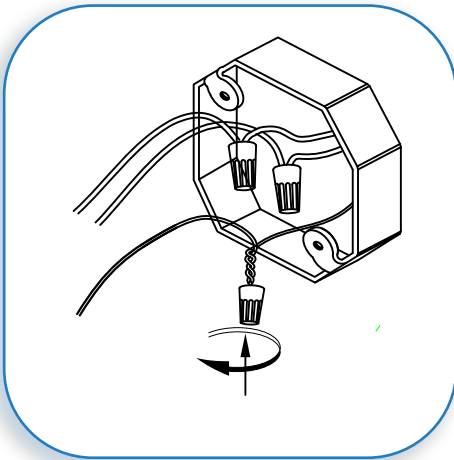

3

MAKE WIRE CONNECTIONS

Gently pull the supply wires through the hole in the crossbar. Connect the black supply wire to the black fixture wire. Secure with the supplied wire nuts. Connect the white supply wires to the white fixture wire. Secure with the supplied wire nuts. Either wrap the green wire around one of the protruding screws or connect it to the supply ground wire. Secure all wire with electrical tape (not supplied).
Tuck all wires carefully into the J-Box.

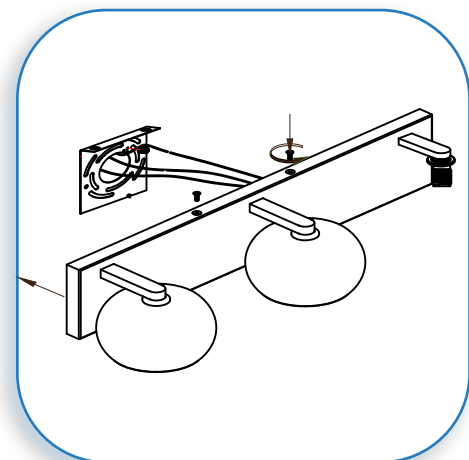

4

MOUNT FIXTURE TO THE CROSSBAR PLATE

Position the fixture plate over the crossbar plate.
Align the holes at the top the plates.
Secure with the supplied screws.

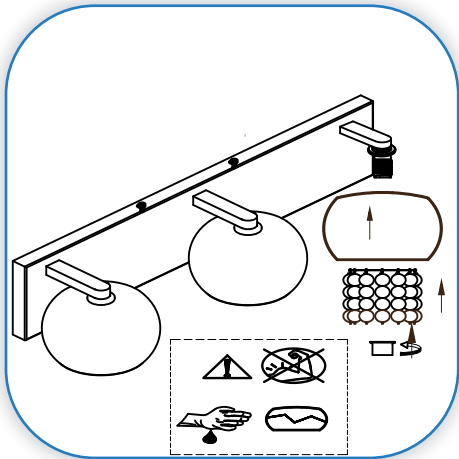

5

SECURE THE GLASS AND CRYSTAL SHADE

Hold the glass and crystal beads shade to the fixture and fit this over the socket. Secure with the supplied socket ring.

Do not tighten the socket ring too much as the glass shade may crack.

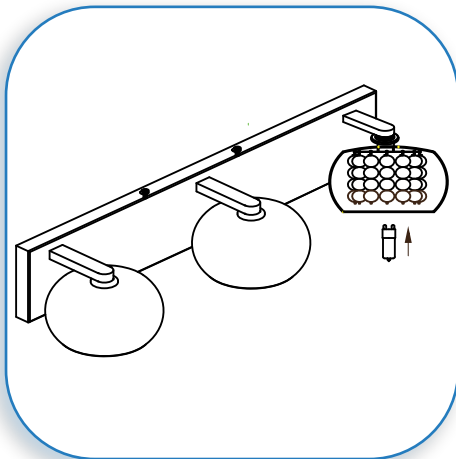

6

INSERT THE BULBS

Insert the supplied bulbs.

MAXIMUM WATTAGE 48W.

DO NOT EXCEED THE WATTAGE AS STATED

ON THE WARNING LABEL AND IN THE INSTRUCTION SHEETS

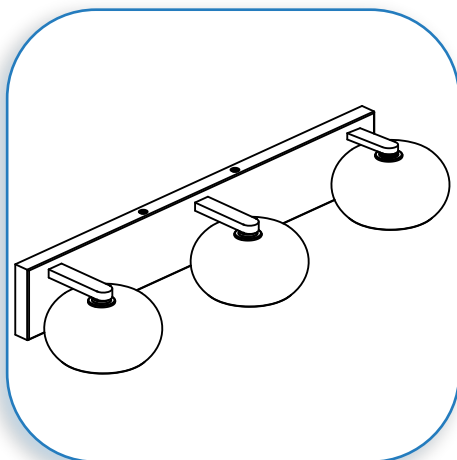

7

RESTORE THE ELECTRICITY AND CHECK THE OPERATION OF YOUR NEW ACCESS FIXTURE

CAUTION Please ensure that the fitting is cool and switched off before replacing the bulb. DO NOT use bulbs that might exceed the maximum wattage, stated on caution label.