

INSTALLATION INSTRUCTIONS

Step 1: Drill holes in Wall for Backplate Mounting

Determine your desired location for installation and make a mark for the location . Make 2 marks where mounting screws will be placed as shown below. Make sure shelf is level when marking for location of installation. Drill hole at each end of the marks.

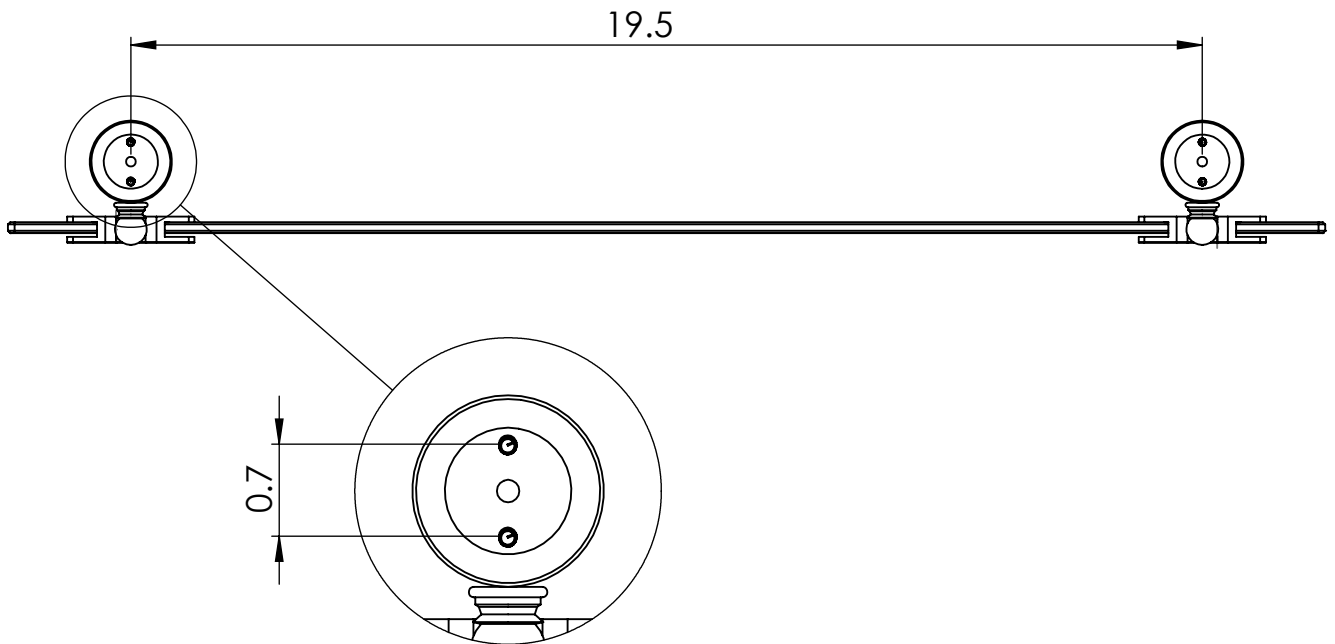

Step 2: Attach Shelf to Backplate

Unscrew Caps. Then mount Backplates to desired location and screw them in place. Then insert shelf into Backplates and screw Caps.

